

IN THE SUPERIOR COURT OF ATHENS-CLARKE COUNTY
STATE OF GEORGIA

ORIGINAL

STATE OF GEORGIA)
)
vs.) CASE NO.: SU-22-CR-0321-S
) SU-23-CR-0477-S
LUKE HARRISON WALDROP,)
) ORIGINAL EXHIBITS
Defendant.)
)

EXHIBITS FROM HEARING ON MARSY'S LAW VIOLATION

Heard before the Honorable Lawton E. Stephens, Judge of the Superior Courts of the Western Judicial Circuit, in the Athens-Clarke County Courthouse, 325 East Washington Street, Athens, Georgia, on November 6, 2023.

A P P E A R A N C E S:

For the State: DEBORAH GONZALEZ, ESQ.
ROBERT WILSON, ESQ.
Office of the District Attorney
Western Judicial Circuit
325 East Washington Street
Athens, Georgia 30601

For Movant Susan Wilson: KEVIN E. EPPS, ESQ.
CLAIRE KIMBRELL, ESQ.
Epps, Holloway, DeLoach &
Hoipkemier, LLC
1220 Langford Drive
Building 200-101
Watkinsville, Georgia 30677

LANE FITZPATRICK, ESQ.
P.O. Box 660
Danielsville, Georgia 30633

Misti H. Colley, C.C.R.
Official Court Reporter
Western Judicial Circuit
P.O. Box 321
Nicholson, Georgia 30565
(706) 202-6384

I N D E X

MOVANT'S WITNESSES

SUSAN WILSON

Direct examination	17
Cross-examination	45
Redirect examination	47

ALICE HAYES

Direct examination	51
Cross-examination	60

DEBORAH GONZALEZ

Cross-examination	69
Continued cross-examination	123

SIMONA ARROYO

Direct examination	105
Cross-examination	122

MICHAEL PROCHASKA

Direct examination	140
Cross-examination	141

JOSH NEAL

Direct examination	142
Cross-examination	145
Redirect examination	146

STATE'S WITNESSES

DEBORAH GONZALEZ

Direct examination	148
Recross-examination	153

ARGUMENT:

Mr. Fitzpatrick	163
Mr. Wilson	173
Mr. Epps	182

THE COURT'S RULING	190
-------------------------------------	------------

MOVANT'S EXHIBITS

ADMITTED

1	Emails between Susan Wilson and Alice Hayes	22
2	Email from Deborah Gonzalez to Susan Wilson	24
3	Trial notice	25
4	Transcript of guilty plea	25
5	Motor vehicle crash report	28
6	Letter from Alice Hayes to Susan Wilson	54
7	Tracker notes	56
8	Response to motion by Deborah Gonzalez	73
9	Emails between Deborah Gonzalez and Lynn Bradberry . .	74
10	Various interoffice emails	76
11	Letter to the editor	87
12	Email	Not admitted
13	Tab Hunter email with status of cases	159
14	Transcript from September 21, 2023	126
15	Writing by Deborah Gonzalez	132
16	Notice of filing subpoenas	162

STATE'S EXHIBITS

ADMITTED

1	Email dated 9/21/23 12:25 a.m.	150
2	Email dated 9/2/23 12:28 a.m.	151

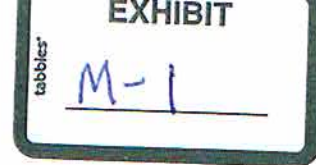

State v. Luke Waldrop: Arraignment, 6/22/22, 9:00am

Inbox

Search for all messages with label Inbox

Remove label Inbox from this conversation

A

Alice Hayes <Alice.Hayes@accgov.com>

Jun 14,
2022,
5:38 PM

to me

Good afternoon, Ms. Wilson,

I hope that you are doing well. This is a courtesy notice to let you know that Luke Waldrop's case is scheduled for Arraignment on June 22 at 9:00 a.m. As a victim in the case, you have the right to attend this hearing if you would like to. (You are not required to attend.)

If you would like to attend the hearing, we recommend that you park in the courthouse parking deck and bring your parking ticket in with you so we can validate it for you. The courthouse is located at the 325 E. Washington Street address below. I would also recommend that you arrive a little before the hearing, and come to our office in Room 370 of the courthouse, so that I can meet you there.

Please let me know if you have any questions, or if there is anything else I can assist you with. One of the services we offer is referral to community resources and other sources of assistance – I would be more than happy to discuss this with you further.

Thank you,

Alice Hayes

Victim Advocate

[she/her/hers]

Office of the District Attorney
Western Judicial Circuit
325 E. Washington St. Rm 370
Athens, GA 30601
Phone - (706) 613-3240 Ext. 6835
Fax - (706) 613-3247

Susan Wilson <susan.wilson1998@gmail.com>

Fri, Jun 24,

2022,
5:26 PM

to Alice

Good afternoon Ms. Hayes,

I am not entirely sure I want to know the answer to this question, but I'll go ahead and ask anyway. Have you learned any more about the plea Luke Waldrop entered on Tuesday -- i.e., was there a plea agreement made, and if so, what did it involve? I would appreciate anything you can tell me about this and the next steps; there are other folks in town (friends of Jim's) who are interested as well, so I would like to be able to tell them something.

Thank you for all your help,

Susan

State v. Luke Waldrop: Arraignment, 6/22/22, 9:00am
Inbox

A
l
i
c
e
H
a
y
e
s

Tue, Jun 28, 2022, 3:28 PM

Ms. Wilson, I hope I can put your mind at ease. No plea agreement has been made. Plea agreements



Susan Wilson <susan.wilson1998@gmail.com>

Tue, Jun 28,
2022, 5:22 PM

to Alice

Dear Alice,

Thank you for the clarification. I'll pass those details along to people who had questions. I think the best day this week for me to meet for a while, either in person or over the phone, will be Thursday afternoon (probably after 2 pm). I do have some questions about financial issues and applying for assistance, which I fear may require some digging for information.

Gratefully,

Susan

Victim Impact Statement

Inbox

Search for all messages with label Inbox

Remove label Inbox from this conversation



Alice Hayes Alice.Hayes@accgov.com via athensclarkecounty0.onmicrosoft.com

2022,

5:38 PM

to me

Ms. Wilson,

Thank you for speaking with me earlier. As requested, attached is a copy of the Victim Impact Statement and other paperwork which we previously mailed.

I will be following up with you via email tomorrow with resources we discussed. In the meantime, here is the [link](#) to Athens Land Trust's Homebuyer Education Classes. The next classes are July 23 and August 20, from 8:30am-4:30pm – since this conflicts with your work schedule, it may be worth calling Athens Land Trust and/or emailing Ayanna Hall, Housing Counselor (ayanna@athenslandtrust.org) to discuss further.

Thank you again for speaking with me, and please let me know if I can be of any further assistance,

Alice Hayes

Victim Advocate

[she/her/hers]

Office of the District Attorney
Western Judicial Circuit

325 E. Washington St. Rm 370
Athens, GA 30601
Phone - (706) 613-3240 Ext. 6835
Fax - (706) 613-3247

One attachment • Scanned by Gmail



11

Jul 15,
2022,
1:56 PM

Susan Wilson <susan.wilson1998@gmail.com>

to Alice

Dear Alice,

Thanks for the copy of the paperwork. I'll work on it tonight. I really need to do that now, as the owner of the house where I live has decided to sell it. I have until September 30 to move out or buy it. Needless to say, I am completely floored.



Susan Wilson <susan.wilson1998@gmail.com>

Jul 15,
2022,
4:02 PM

to Alice

What was the name of the program you mentioned in our conversation yesterday? Not the Homebuyer Education workshop (don't know if I could get in on one soon enough to do me any good), but the other one (Georgia Dream, I think?)?

Thanks for all your help,

Susan

Susan Wilson <susan.wilson1998@gmail.com>

Fri, Jul 15,
2022,
1:56 PM

to Alice

Dear Alice,

Thanks for the copy of the paperwork. I'll work on it tonight. I really need to do that now, as the owner of the house where I live has decided to sell it. I have until September 30 to move out or buy it. Needless to say, I am completely floored.



Susan Wilson <susan.wilson1998@gmail.com>

Fri, Jul 15,
2022,
4:02 PM

to Alice

What was the name of the program you mentioned in our conversation yesterday? Not the Homebuyer Education workshop (don't know if I could get in on one soon enough to do me any good), but the other one (Georgia Dream, I think?)?

Thanks for all your help,

Susan

Checking in

Inbox

Search for all messages with label Inbox

Remove label Inbox from this conversation



Susan Wilson <susan.wilson1998@gmail.com>

Sep 27,
2022,
8:33 PM

to Alice

Hello. I got your message and I thought I had responded, but I didn't hear back from you. I have a few moments before the library closes so I wanted to check in with you.

If I didn't tell you before, I did lose my chance to buy the house; I don't know all the details, but the upshot is, the person who lives next door made an offer on the house that my landlady accepted, before I could get my offer put together. This Friday is my

last day in that house. As you might guess, packing up and working out where to live has consumed all the attention I have outside of work, so I haven't thought to check in before now. I do have a place to stay for a few months -- some long-time friends are letting me stay with them, in one of their daughters' rooms (they have been grown and gone for several years, so there is space). After a bit of settling and adjusting, I plan to start looking for a place of my own, and a friend who works for Coldwell Banker has offered to help.

I hope you have been doing well, and that your last communication was not to send me important news, like trial dates or charge dismissals. Please send me an email to let me know that you got this, and if there is anything you think I should know about the case, or anything else.

I really appreciate all your help over the last few months and hope things progress as we would like. I hope to talk to you soon.

Thanks again,

Susan

From: Susan Wilson <susan.wilson1998@gmail.com>
Sent: Tuesday, September 27, 2022 8:34 PM
To: Alice Hayes <Alice.Hayes@accgov.com>
Subject: [EXT]Checking in

EXTERNAL SENDER: This email originated from outside of the organization. Do not click links or open attachments unless you recognize the sender and know the content is safe.

Hello. I got your message and I thought I had responded, but I didn't hear back from you. I have a few moments before the library closes so I wanted to check in with you.

If I didn't tell you before, I did lose my chance to buy the house; I don't know all the details, but the upshot is, the person who lives next door made an offer on the house that my landlady accepted, before I could get my offer put together. This Friday is my last day in that house. As you might guess, packing up and working out where to live has consumed all the attention I have outside of work, so I haven't thought to check in before now. I do have a place to stay for a few months -- some long-time friends are letting me stay with them, in one of their daughters' rooms (they have been grown and gone for several years, so there is space). After a bit of settling and adjusting, I plan to

start looking for a place of my own, and a friend who works for Coldwell Banker has offered to help.

I hope you have been doing well, and that your last communication was not to send me important news, like trial dates or charge dismissals. Please send me an email to let me know that you got this, and if there is anything you think I should know about the case, or anything else.

I really appreciate all your help over the last few months and hope things progress as we would like. I hope to talk to you soon.

Thanks again,

Susan

On Wed, Sep 28, 2022 at 8:29 AM Alice Hayes <Alice.Hayes@accgov.com> wrote:

Good morning, Ms. Wilson,

Thank you for reaching out. My last communication was to “check in” and see how you are doing, so please don’t worry about having missed any updates. I didn’t get a response from you, but I understood that it has been a very busy time for you.

I am so sorry to hear about the house – I know that this is not the outcome you had hoped for. Is there anything you need at the moment, or anything I can do to help you?

I don’t have any updates for you about the case at this time, but you are always welcome to call/email to check. I’d be happy to chat with you whenever is convenient for you. Could you let me know when you’ll be available for a phone call?

Please let me know if there is anything I can assist you with,

Alice Hayes

Victim Advocate

[she/her/hers]

Office of the District Attorney

Western Judicial Circuit

325 E. Washington St. Rm 370

Athens, GA 30601

Phone - (706) 613-3240 Ext. 6835

Fax - (706) 613-3247

From: Susan Wilson <susan.wilson1998@gmail.com>

Sent: Wednesday, September 28, 2022 9:33:59 AM

To: Alice Hayes <Alice.Hayes@accgov.com>

Subject: Re: [EXT]Checking in

Dear Alice,

Thanks for getting back to me so fast. No, this is definitely NOT how I wanted things to go, but there's nothing constructive I can do about it now, so I have to stiffen the old upper lip and press on.

I haven't really had a chance to think about much but what's right in front of me for the past couple weeks, so I can't think of anything beyond that at the moment. Once I get more settled in my temporary digs I can start looking further out and further ahead. Some wonderful friends have been helping me a LOT and looking for me, but I think I need to step back for a day or two before I jump back into thinking about the future.

As for the call, Friday may be the best day this week. I am not working and will be spending the day not moving and/or doing some limited unpacking.

Thanks for everything. I hope everything is going well for you and your other clients (best word I could think of).

Bye for now.

Susan

Alice Hayes <Alice.Hayes@accgov.com>
To: Susan Wilson <susan.wilson1998@gmail.com>

Thu, Sep 29, 2022 at 6:15 PM

Ms. Wilson,

When would you like to chat tomorrow? My schedule is open, so whenever works for you.

Thanks,

Alice Hayes

Get [Outlook for iOS](#)

----- Forwarded message -----

From: **Deborah Gonzalez** <Deborah.Gonzalez@accgov.com>

Date: Tue, Sep 26, 2023 at 3:14 PM

Subject: Luke Waldrop SU-23-CR-0477-S

To: susan.wilson1998@gmail.com <susan.wilson1998@gmail.com>

Cc: Simona Arroyo <Simona.Arroyo@accgov.com>, Robert Wilson <Robert.Wilson@accgov.com>, Deborah Gonzalez <Deborah.Gonzalez@accgov.com>, Lynn Bradberry <Lynn.Bradberry@accgov.com>

Good afternoon Ms. Wilson:

My victim advocate gave me your name and contact information, as well as a list of questions you had regarding the resolution of the Luke Waldrop case.

First let me say how sorry we are for your loss. These tragedies are difficult on so many levels. Vehicular Homicide cases are always hard because the sentence never measures up to the loss of a life.

My team helped me to understand the case and the plea. Here are some answers. Let Simona know if you have any additional questions.

Question #1 – below is all the contact that has been made to you since the case came into the office. This case was arraigned in June 2022 but it was never placed on a trial calendar until this one.

Question #2 – Our system does not note who initiated the plea. Our judges do request that a plea offer is made in each case. We do have a note that our Victim Advocate attempted to notify you and the victim's sister the day of the plea based on notes that we received the night before.

Question #3 – Yes – our victim advocate personally gave the ADAs in the courtroom the information that the victims were not happy with the plea offer and that they wanted jail time. This was conveyed to the judge. The judge thought about it for a little bit before deciding to accept the plea.

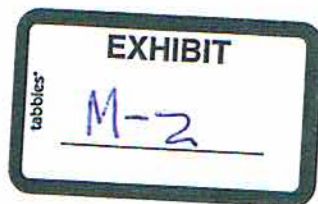

Question #4 – The newspaper does not always print things correctly nor does the media have all the evidence and facts. There were mitigating facts that would make this a difficult case to prove beyond a reasonable doubt for VH in the first degree. For example, the hospital refused to comply with the search warrant to take the defendant’s blood. This occurred late at night about 11:30 pm. There is no evidence that the defendant left his lane of travel. The defendant’s performance on Field Sobriety Tests was poor according to the officers but there was no body cam without which we could not prove the felony. At the end we would have probably ended up with VH in second degree even after the trial.

Question #5 – Every crime has certain elements, each of which must be proven beyond a reasonable doubt. There was not enough admissible evidence to prove this as a felony.

Question #6 – The court was notified that the victims wanted jail time but chose to allow him to plead to straight probation.

Question #7 – these cases are always hard because they do involve a death; however, GA’s law regarding VH in the 2nd Degree is a misdemeanor.

Question #8 – Prosecutor presented the court with a factual basis that included the circumstances surrounding how the incident occurred. The judge gave careful consideration to the factual basis and that the victims wanted jail time before ultimately allowing the defendant to plead guilty to the misdemeanor of Homicide by Vehicle in the Second Degree and Improper Passing.

Question #9- Victims have the right to be heard; which did happen because we informed the court on the record of the victim’s wishes for jail time; however, the ultimate prosecutorial decision on what should happen with criminal cases is within the discretion of the District Attorney’s Office, with the judge making the final decision whether to accept the plea or not.

Jame’s sister, Melody, was notified as well, and although she was not in agreement with the plea, she understand the issues and the legal process.

Victim/Witness	Date	Service	Note	Staff
Susan Wilson	09/25/2023	4 services	Susan called in with more questions for the plea that was accepted on her case. Provided answers that I could. Advised that I would call back with other answers when I get them.	Simona Arroyo Show/Edit
Susan Wilson	09/21/2023	4 services	Called to give result of plea. Offered additional support if needed.	Simona Arroyo Show/Edit

Susan Wilson	09/21/2023	4 services	TTC partner to give details of plea offer and to notify of upcoming trial LVM	Simona Arroyo	Show/Edit
Susan Wilson	09/30/2022	Individual Support	TTC V as she requested - no answer, left vm & texted, per V request	Alice Hayes	Show/Edit
Susan Wilson	09/28/2022	2 services	Rec'd & responded to email from V - see notes	Alice Hayes	Show/Edit
Susan Wilson	08/30/2022	Individual Support	Called V to "check in" - no answer, left vm stating I was calling to check in & see how everything is going, & could V please return my call @ her convenience	Alice Hayes	Show/Edit
Susan Wilson	08/12/2022	2 services	Emailed V list of counseling resources - see notes	Alice Hayes	Show/Edit
Susan Wilson	08/10/2022	4 services	Meeting w/ V (1hr 10mins) to advise on VIS and restitution form; discuss needs/resources (see notes)	Alice Hayes	Show/Edit
Susan Wilson	08/04/2022	Individual Support	Called V to "check in" - see notes. Scheduled appointment w/ V for 8/10/22 @ 9:30	Alice Hayes	Show/Edit
Susan Wilson	07/15/2022	2 services	Rec'd 2 emails from V- see notes; did not respond to emails, called her instead. Sent separate email with possible resources; see notes.	Alice Hayes	Show/Edit
Susan Wilson	07/14/2022	5 services	Emailed copy of initial contact/intake paperwork, per V request	Alice Hayes	Show/Edit
Susan Wilson	07/14/2022	2 services	TC to V, discussed financial needs & possible resources - see notes. Emailed link/referral to Athens Land Trust Homebuyer Education Classes.	Alice Hayes	Show/Edit
Susan Wilson	07/14/2022	Individual Support	TC to V, discussed financial needs & possible resources - see notes. Emailed link/referral to Athens Land Trust Homebuyer Education Classes.	Alice Hayes	Show/Edit
Susan Wilson	07/06/2022	2 services	Emailed V list of financial assistance resources - see notes	Alice Hayes	Show/Edit

Susan Wilson	06/30/2022	Individual Support	Called to discuss V's financial needs - V asked if I could call her back Tuesday morning. Advised I will be in trial but Tuesday morning could work- depends on how long jury selection lasts. Will f/u with V.	Alice Hayes	Show/Edit
Susan Wilson	06/27/2022	2 services	Called V - she was teaching class & couldn't talk. Let her know I got her email & responded but we're having server issues; I will re-send ASAP.	Alice Hayes	Show/Edit
Susan Wilson	06/27/2022	5 services	Responded to email from V - email immediately bounced back, we are having internet issues today. Will re-send ASAP.	Alice Hayes	Show/Edit
Susan Wilson	06/22/2022	4 services	Notified of Arraignment outcome (in person- Ms. Wilson attended Arraignment)	Alice Hayes	Show/Edit
Susan Wilson	06/22/2022	CJS Victim Support & Advocacy	Attended court with Susan Wilson	Alice Hayes	Show/Edit
Susan Wilson	06/22/2022	CJS Victim Notification	ACC phones are down/cannot receive incoming calls - texted V so she'd have a way to contact me	Alice Hayes	Show/Edit
Susan Wilson	06/21/2022	4 services	Rec'd call from V - discussed what to expect tomorrow (Arraignment)	Alice Hayes	Show/Edit
Susan Wilson	06/17/2022	2 services	V called - wanted to know if she can have a friend accompany her to arraignment for support. Advised that should be fine	Alice Hayes	Show/Edit

Susan Wilson	06/14/2022	4 services	Notified of Arraignment via phone & email - see notes	Alice Hayes	Show/Edit
2 victims	05/17/2022	2 services	Attended court	Alice Hayes	Show/Edit
Susan Wilson	04/15/2022	2 services	Texted V to confirm email address & contact info for Melody Jones	Alice Hayes	Show/Edit
Susan Wilson	04/15/2022	2 services	Emailed V, per her request - it bounced back undeliverable. Will text instead.	Alice Hayes	Show/Edit
Susan Wilson	04/15/2022	4 services	Mailed initial contact packet	Alice Hayes	Show/Edit
Susan Wilson	04/15/2022	4 services	TC from V - see notes	Alice Hayes	Show/Edit
Susan Wilson	04/15/2022	CJS Victim Support & Advocacy	Received vm from V. Returned her call, no answer, left vm.	Alice Hayes	Show/Edit
Susan Wilson	04/12/2022	CJS Victim Notification	TC to V to introduce self - no answer, left vm asking Susan Wilson to return my call	Alice Hayes	Show/Edit

From: Simona Arroyo <Simona.Arroyo@accgov.com>

Date: Tuesday, September 26, 2023 at 10:12 AM

To: Deborah Gonzalez <Deborah.Gonzalez@accgov.com>, Robert Wilson <Robert.Wilson@accgov.com>

Cc: Simona Arroyo <Simona.Arroyo@accgov.com>
Subject: Luke Waldrop SU-23-CR-0477-S

Good morning,

The victim's partner of 37 years, Susan Wilson (706-461-6713) called in on Friday and on yesterday to discuss the outcome of the plea that Waldrop took. She was understandably upset and had several questions: A few that I had answers for and some I did not have answers for. She also made reference to a news article that was published about the case. I met with Robert and he thought it best to bring you in on this.

1. She wanted to know why she hadn't been contacted for the past year prior to my initial contact with her. In summary, I apologized and let her know that is not reflective of how we interact with victims in this office. **See all contact listed above**
2. Who put the plea on the table? Our office or the Defense Office?
3. Where her wishes taken into account at all at any point in time and was it told/given to the judge?
4. Why did the news article say that there wasn't enough evidence when the pictures and police report show and state plenty of evidence?
5. How was a felony death plead down to a misdemeanor?
6. Why wasn't time to serve given? Was it not an option?
7. How can a death be a misdemeanor?
8. What evidence was presented when it was obvious by the pictures and police report that Waldrop was DUI?
9. Is there anything that the victim survivors can do to reject or protest the judgement?

I did advise her that either myself, or someone from this office will return her call when we have answers for her questions and concerns.

Thank you,

Simona Arroyo

Victim Advocate

District Attorney's Office

Western Judicial Circuit

325 E. Washington St.

Suite 370

Athens, GA 30601

Direct Phone: (762) 400-6814

Office Phone: (706) 613-3240 Ext. 6814

Fax: (706) 613-3247

 A411DB48

The Unified Government of Athens-Clarke County is a public entity subject to Georgia's Open Records Act OCGA sections 50-18-70 to 50-18-76. Email messages are covered under such laws and are subject to disclosure unless specifically protected by law.

2 attachments



image001.png
26K



image001.png
26K

CLARKE COUNTY - LAWTON E. STEPHENS

TRIAL NOTICE

Criminal Action Number SU22CR0321
 Defendant LUKE HARRISON WALDROP
 LAWTON E. STEPHENS

YOU ARE REQUIRED BY LAW TO BE PRESENT. HERRIN FAN. NOT.

To:

LUKE HARRISON WALDROP
 640 SKIDDER ROAD
 CAMDEN, SC 29322

You are hereby notified that the case against the above-named defendant will be called for a Plea Calendar on September 21st, 2023 at 09:00AM and a Trial Calendar on September 25th, 2023 at 09:00AM in CLARKE County SUPERIOR Court in courtroom 301. The defendant is required to be present for the call of this case. SEE OTHER JUDICIAL NOTICE FOR IMPORTANT INFORMATION.

You have the right to be represented by an attorney. You may be eligible for the appointment of an attorney to represent you, if you are indigent. If you do not have an attorney and believe you are indigent, you may apply at Indigent Defense to determine if you are eligible for an appointed attorney.

Count 1) HOMICIDE BY VEHICLE IN 1ST DEGREE
 Count 2) D.U.I. ALCOHOL
 Count 3) HOMICIDE BY VEHICLE IN 1ST DEGREE
 Count 4) RECKLESS DRIVING

I, the undersigned Clerk of the court named herein, certify that I have on this date mailed to the above-named defendant, defendant's attorney, and bookskeeper of record at the address above above and of record in the above styled case a true and correct copy of the above and foregoing notice by depositing the same in the United States Post Office in an envelope properly addressed and stamped. You are required to be present or the Bond will be forfeited. This is the only notice you will receive.

This 29th day of August, 2023.

Elisa Zarate

ELISA ZARATE
 Clerk of the SUPERIOR Court
 CLARKE COUNTY, GEORGIA

CC: LIBERTY BONDING COMPANY, Surety
 ROBBIE M BALLARD, Attorney for Defendant

IN THE SUPERIOR COURT OF ATHENS-CLARKE COUNTY

STATE OF GEORGIA

STATE OF GEORGIA)
)
 vs.) CASE NO.: SU-23-CR-0477-S
)
 LUKE HARRISON WALDROP,)
)
 Defendant.)

TRANSCRIPT OF GUILTY PLEA

Heard before the Honorable Lawton E. Stephens, Judge of the Superior Courts of the Western Judicial Circuit, in the Athens-Clarke County Courthouse, 325 East Washington Street, Athens, Georgia, on September 21, 2023.

A P P E A R A N C E S:

For the State: DEBORAH GONZALEZ, ESQ.
 JOSH NEAL, INTERN
 Office of the District Attorney
 Western Judicial Circuit
 325 East Washington Street
 Athens, Georgia 30601

For the Defendant: ROBBIE M. BALLARD, ESQ.
 Hanks, Ballard & Barth, LLC
 P.O. Box 710
 Monroe, Georgia 30655

Misti H. Colley, C.C.R.
 Official Court Reporter
 Western Judicial Circuit
 P.O. Box 321
 Nicholson, Georgia 30565
 (706) 202-6384

1 THE COURT: Are we ready on Luke Harrison Waldrop?
2 Is there anybody here on that? Mr. Ballard?

3 MS. GONZALEZ: Yes, Your Honor. We just brought up
4 the accusation.

5 MR. BALLARD: Robbie Ballard for Mr. Waldrop, Your
6 Honor.

7 THE COURT: Come on up.

8 MR. BALLARD: Good morning, Your Honor.

9 THE COURT: Good morning. We don't have any
10 paperwork on it. Is there a plea bargain?

11 MS. GONZALEZ: Yes, there is, Your Honor, here. It
12 just got finalized.

13 MR. BALLARD: It is a negotiated plea, Your Honor.

14 THE COURT: All right. Count 1, homicide by vehicle;
15 Count 2, DUI alcohol; Count 3, homicide by vehicle in the
16 first degree; Count 4, reckless driving.

17 CLERK: Judge, there's been a new accusation filed.
18 I just have not had a chance to file it in yet.

19 THE COURT: Oh, okay. Let me know when you're ready.

20 CLERK: There's a copy.

21 THE COURT: All right. All right. I'll hear from
22 the State. Go ahead.

23 MR. NEAL: Thank you, Your Honor. I'll again say
24 this is State of Georgia versus Luke Harrison Waldrop. I
25 don't have the case number of the new accusation.

1
2
3
4
5
6
7
8
9
10
11
12
13
14
15
16
17
18
19
20
21
22
23
24
25

THE COURT: It's SU23CR0477.

MR. NEAL: Thank you, Your Honor. We're here today to enter into a negotiated plea agreement on Counts 1 and 4; Count 1 being homicide by vehicle in the second degree and Count 4 being --

THE COURT: There's only two counts to this accusation, Mr. Neal.

MR. NEAL: My apologies. Then Count 2 being improper passing of a bicycle. That was from the --

THE COURT: Count 1 is homicide by vehicle in the second degree and Count 2 is passing -- safe passing distance when overtaking a bicyclist is what I'm showing.

MR. NEAL: Yes, Your Honor. Sorry.

THE COURT: Have you got a copy of it?

MR. NEAL: I --

THE COURT: For some reason, the four counts of the new accusation are still on the back of the -- I mean, from the old accusation are still on the back of the new accusation. That needs to be deleted.

MR. NEAL: Yes, Your Honor. I will continue. Sorry. Again, those -- with those charges -- the terms of that negotiated plea agreement are on Count 1, homicide by vehicle in the second degree, that is 12 months probation with a \$1,000 fine, 40 hours of community service, with the completion of a Georgia DDS approved defensive driving

1 course. And for Count 4 of improper passing a bicycle, 12
2 months probation consecutive to Count 1 with a \$500 fine.
3 And those are the terms of the agreement.

4 Mr. Waldrop, would you please raise your right hand?

5 [Defendant is sworn by Mr. Neal.]

6 MR. NEAL: Could you please state your true, correct
7 and legal name?

8 DEFENDANT WALDROP: Luke Harrison Waldrop.

9 MR. NEAL: Could you spell your first and last?

10 DEFENDANT WALDROP: L-U-K-E, W-A-L-D-R-O-P.

11 MR. NEAL: And are you the person charged in the
12 above case?

13 DEFENDANT WALDROP: Yes sir.

14 MR. NEAL: Are you able to hear me and understand my
15 questions and statements?

16 DEFENDANT WALDROP: Yes sir.

17 MR. NEAL: Are you under the influence of any
18 alcohol, drugs or medication?

19 DEFENDANT WALDROP: No sir.

20 MR. NEAL: Has your lawyer explained your charges
21 against you?

22 DEFENDANT WALDROP: Yes sir.

23 MR. NEAL: Do you understand that you have a right to
24 a jury trial?

25 DEFENDANT WALDROP: Yes sir.

1 MR. NEAL: Do you understand that you could have a
2 jury trial by pleading not guilty or by remaining silent
3 and not entering a guilty plea?

4 DEFENDANT WALDROP: Yes sir.

5 MR. NEAL: Do you understand that by pleading guilty,
6 you are waiving all defenses?

7 DEFENDANT WALDROP: Yes sir.

8 MR. NEAL: Do you understand that you are entitled to
9 the presumption of innocence?

10 DEFENDANT WALDROP: Yes sir.

11 MR. NEAL: Do you understand that you have the right
12 to assistance of counsel during trial?

13 DEFENDANT WALDROP: Yes sir.

14 MR. NEAL: Do you understand that you have the right
15 to not incriminate yourself?

16 DEFENDANT WALDROP: Yes sir.

17 MR. NEAL: Do you understand that at a jury trial
18 that you would have -- that at a jury trial you'd have the
19 right to question witnesses against you, the right to
20 subpoena witnesses on your own behalf, and the right to
21 testify yourself and offer other evidence?

22 DEFENDANT WALDROP: Yes sir.

23 MR. NEAL: Do you understand that by pleading guilty
24 you're giving up all these rights?

25 DEFENDANT WALDROP: Yes sir.

1 MR. NEAL: Are you an American citizen?
2 DEFENDANT WALDROP: Yes sir.
3 MR. NEAL: Have you had the chance to discuss your
4 case with your attorney?
5 DEFENDANT WALDROP: I have.
6 MR. NEAL: And are you satisfied with the services of
7 your attorney?
8 DEFENDANT WALDROP: I am.
9 MR. NEAL: I'm sorry, sir, I don't know your name,
10 but have you explained these rights and charges to your
11 client and do you believe he understands?
12 MR. BALLARD: My name is Robbie Ballard and I have.
13 MR. NEAL: Thank you, sir. Do you understand, Mr.
14 Waldrop, that this is a negotiated plea?
15 DEFENDANT WALDROP: Yes sir.
16 MR. NEAL: Do you understand that the Court is not
17 bound by any promises or recommendations and that the
18 Court can impose up to the maximum sentence in this --
19 MR. BALLARD: Pardon me? I'm sorry. I thought you
20 had said something.
21 MR. NEAL: Oh, I apologize. Sorry.
22 MR. BALLARD: Forgive me. I'm sorry.
23 MR. NEAL: I'll repeat that.
24 DEFENDANT WALDROP: Okay. Thank you.
25 MR. NEAL: Do you understand that the Court is not

1
2
3
4
5
6
7
8
9
10
11
12
13
14
15
16
17
18
19
20
21
22
23
24
25

bound by any promises or recommendations and that the Court can impose up to the maximum sentence in this case?

DEFENDANT WALDROP: Yes sir.

MR. NEAL: Do you understand that if the judge imposes a sentence greater than the negotiated plea that you'd have the right to withdraw your plea at the time of sentencing?

DEFENDANT WALDROP: Yes sir.

MR. NEAL: Do you understand that this plea may be used to enhance sentencing on other convictions in this jurisdiction and other jurisdictions, including federal court?

DEFENDANT WALDROP: Yes sir.

MR. NEAL: Has anyone made any threats or promises to influence you to plead guilty in this matter?

DEFENDANT WALDROP: No.

MR. NEAL: Do you and your attorney stipulate to a factual basis for the entry of your plea?

DEFENDANT WALDROP: We do.

MR. BALLARD: We do.

MR. NEAL: Thank you. And how do you plead?

DEFENDANT WALDROP: Guilty.

MR. NEAL: And did you in fact commit that offense?

DEFENDANT WALDROP: Yes.

MR. NEAL: There are three ways to challenge this

1 guilty plea. The first way being that you can directly
2 appeal your plea of guilty by filing a notice of appeal
3 within 30 days of today. Second, you may file what's
4 called a habeas corpus petition. And your lawyer can
5 explain to you better what that is, but the important
6 thing I must advise you is that you have four days -- or
7 four years -- excuse me -- from today for a felony charge
8 or 12 months for a misdemeanor charge to file that
9 petition. Do you understand those filing -- that filing
10 deadline?

11 DEFENDANT WALDROP: Four years. And what was the
12 second one?

13 MR. NEAL: And 12 -- 12 months for misdemeanor
14 charges.

15 DEFENDANT WALDROP: Okay. Yes.

16 MR. NEAL: Sorry. Thank you. And the third way you
17 could challenge this plea is by filing a withdrawal of the
18 guilty plea before this term of court expires.

19 DEFENDANT WALDROP: Okay.

20 MR. NEAL: Have you understood all the questions I've
21 asked you today?

22 DEFENDANT WALDROP: I have.

23 MR. NEAL: And have you given truthful answers?

24 DEFENDANT WALDROP: Yes sir.

25 MR. NEAL: Your Honor, I believe the plea is freely

1
2
3
4
5
6
7
8
9
10
11
12
13
14
15
16
17
18
19
20
21
22
23
24
25

and voluntarily entered.

THE COURT: So your accusation says he violated 40-6-393(a), which is homicide by vehicle in the first degree. So it's a defective accusation if he's pleading to homicide by vehicle in the second degree, if I'm reading it right.

MR. NEAL: I see that.

THE COURT: Because it's -- homicide by vehicle in the second degree is subsection (c) of that code section.

MR. NEAL: Yes, Your Honor.

THE COURT: I'm not seeing -- because it's any person who causes the death of another person without an intention to do so by violating any provision of this title --

MR. NEAL: Yes, Your Honor. I believe it's correct up in --

THE COURT: 40-6-56(a)(2) is a provision of that title.

MR. NEAL: Yes, Your Honor. I believe that is an error in the -- in the wording of the --

THE COURT: In violation of 40-6-393(a), which is homicide by vehicle in the first degree. So --

MR. NEAL: I believe on the charges on the top right, Your Honor, it is correct in that 393(c). I believe it's incorrect in the wording of the accusation.

1 THE COURT: Do you want to make -- do you want to
2 make a correction on the original accusation?

3 MS. GONZALEZ: We can, Your Honor, with an initial.

4 THE COURT: Go ahead. Make -- make the correction on
5 the original accusation.

6 MR. NEAL: We did make an initial, Your Honor, for
7 the record.

8 MR. BALLARD: Your Honor, do we also want to amend
9 the back of this accusation to remove --

10 THE COURT: I think you just need to just cross it
11 out because it's totally -- it just repeated what was on
12 the original indictment. So you might as well just line
13 it out.

14 MR. BALLARD: So, Your Honor, we've lined it out and
15 I've initialed it.

16 THE COURT: All right.

17 MR. BALLARD: And the assistant district attorney has
18 initialed as well.

19 THE COURT: Has the family of the deceased been
20 consulted?

21 MS. GONZALEZ: Yes, Your Honor.

22 THE COURT: So can you maybe elaborate on that? Who
23 was contacted and what was their response to this -- to
24 this plea bargain?

25 MR. NEAL: Your Honor, I believe our victim's

1 advocate has left the room for just a moment. If we could
2 get her back here, we could get that information to you.

3 THE COURT: So you don't know that of your own
4 accord?

5 MR. NEAL: Excuse me, sir?

6 THE COURT: Y'all don't -- you can't tell me right
7 now whether or not the victim of the deceased --

8 MS. GONZALEZ: We know that --

9 THE COURT: -- the family members of the guy that
10 this guy killed --

11 MR. NEAL: Yes -- yes sir.

12 THE COURT: -- whether or not they've been consulted
13 on this plea bargain?

14 MR. NEAL: I do know they have been consulted, sir.

15 MS. GONZALEZ: Yes.

16 MR. NEAL: I just don't know what was said.

17 THE COURT: Mr. Waldrop, have you had enough time to
18 talk to your lawyer about this case?

19 DEFENDANT WALDROP: Yes, Your Honor.

20 THE COURT: Do you understand all the rights that you
21 would be giving up if you decide to enter a plea today?

22 DEFENDANT WALDROP: Yes, Your Honor.

23 THE COURT: Do you understand the plea bargain is not
24 binding on the Court, but if I decide to accept -- if I
25 decide not to accept it, then I'll tell you and you can go

1 to trial in this case?

2 DEFENDANT WALDROP: Yes, Your Honor.

3 THE COURT: Do you understand you have the right to a
4 jury trial?

5 DEFENDANT WALDROP: Yes, Your Honor.

6 THE COURT: Do you understand if you had a jury trial
7 -- and you're number one on the trial calendar for next
8 week for Monday -- that if you had a jury trial then you
9 would -- the State would have to prove these allegations
10 against you beyond a reasonable doubt?

11 DEFENDANT WALDROP: Yes, Your Honor.

12 THE COURT: Do you understand if you had a jury trial
13 then you'd be able to confront the witnesses the State
14 would call to testify against you, you could never be
15 required to testify unless you wanted to, and you could
16 never be required to incriminate yourself?

17 DEFENDANT WALDROP: Yes, Your Honor.

18 THE COURT: Do you want a jury trial?

19 DEFENDANT WALDROP: [No verbal response.]

20 THE COURT: Do you want a jury trial?

21 DEFENDANT WALDROP: Well, I'm -- will that happen if
22 this isn't accepted? No. Yeah, no, I don't. Sorry. No,
23 Your Honor.

24 THE COURT: All right. Do you have any questions you
25 want to ask your lawyer, the district attorney, or the

1
2
3
4
5
6
7
8
9
10
11
12
13
14
15
16
17
18
19
20
21
22
23
24
25

Court?

DEFENDANT WALDROP: No, Your Honor.

THE COURT: And have you been able to understand every question that's been asked of you here today?

DEFENDANT WALDROP: I have been, Your Honor. Thank you.

THE COURT: All right. I find the requirements of voluntariness have been met. You may enter your plea if that's what you want to do.

DEFENDANT WALDROP: Yes sir. Yes, Your Honor.

THE COURT: All right. Mr. Ballard, I'm going to have -- you're going to have to convince me why I should take this plea bargain. I'll hear from you.

MR. BALLARD: Your Honor, on the night of these events, Mr. Waldrop was driving home from downtown and did not provide enough clearance to a bicycle that he was approaching on north Tallassee Road. The area where this occurred, it's dark. There are no lights. My review of the evidence disclosed that the -- the clothing worn by the decedent were not reflective in nature and that there might have been a taillight on the bike that might've been dimly working. But from my review of the videos, I couldn't tell.

At the time that Mr. Waldrop was driving home, he was making the very bad decision of eating a Subway sandwich

1 and trying to change the station on the radio all at the
2 same time. And I think it was the culmination of eating
3 and trying to drive a car and manipulate a radio and the
4 attendant circumstances of Tallassee Road as we all know
5 it before construction began, when it was dark, there are
6 no lights, and a person on a bicycle that he couldn't see.
7 Not to mention that it appears from a review of the
8 evidence and of the videos from the case that the decedent
9 was wearing sunglasses. That neither one of them saw each
10 other and it just happened.

11 I can tell you that Mr. Waldrop has spent the past 18
12 months -- he's a South Carolina resident, a graduate of
13 Clemson University. He had just moved to Athens to kind
14 of start his life after college. And the past 18 months,
15 he's spent pretty much sitting at his parents' home in
16 South Carolina thinking every day about what's happened.
17 He has had -- been receiving psychological treatment as a
18 result of this. He is struggling to get past it. But he
19 stands here before the Court to accept responsibility for
20 what he did.

21 I understand that -- that Mr. Jones is deceased. But
22 Mr. Waldrop will go forward with the rest of his life
23 living with what he did. I can tell you as a defense
24 attorney that these cases seem to be the hardest because
25 there really are two victims. Everybody who has been

1 exposed to this case is sorry for what happened to Mr.
2 Jones. But at the same time, Your Honor --

3 THE COURT: So he wasn't drinking alcohol?

4 MR. BALLARD: He had consumed alcohol earlier in the
5 evening, Your Honor. But the evidence doesn't indicate
6 that alcohol is a contributing factor and certainly
7 doesn't -- isn't -- there isn't enough evidence to
8 establish that his consumption of alcohol is the proximate
9 cause of the accident. And that's how in my negotiations
10 with the State that we arrived at this plea.

11 Going back, you know, Mr. Waldrop is going to live
12 the rest of his life trying to -- trying to cope with what
13 happened to Mr. Jones. And so, you know, given -- given
14 the misfortune that's involved, you know, we -- Your
15 Honor, we ask the Court to accept the plea that we've
16 negotiated with the State.

17 THE COURT: What about restitution, Mr. Neal?

18 MR. NEAL: Your Honor, we have spoken with the family
19 of the victim and they have been notified of any -- of the
20 offer in this case, Your Honor. And they have been
21 notified of the problems that we were receiving with
22 evidence, Your Honor. And they are in formal disagreement
23 with the -- with the plea agreement, Your Honor, and wish
24 for the defendant to serve jail time.

25 MR. BALLARD: Your Honor, if I could comment on

1
2
3
4
5
6
7
8
9
10
11
12
13
14
15
16
17
18
19
20
21
22
23
24
25

restitution. The decedent's family in this case were represented by Kenny Kalivoda --

THE COURT: Okay.

MR. BALLARD: -- of Hudson, Montgomery, Kalivoda.

THE COURT: All right.

MR. BALLARD: I have received letters from insurance carriers.

THE COURT: Okay.

MR. BALLARD: The case settled for the policy limits. And so to the extent that it is even financially possible, there has been restitution.

THE COURT: Well, the State is not requesting it. It's not in the bargain. So --

MR. NEAL: That's correct, Your Honor.

THE COURT: All right. So did he -- did he get -- I'm assuming he got locked up the night of the event. Did he serve any time before he bonded out?

MR. BALLARD: Your Honor, he spent one day in jail. Approximately one day.

THE COURT: Yeah.

MR. BALLARD: Your Honor, I might also add that Mr. Waldrop hasn't driven a car since this happened. That -- that's -- I think I've --

THE COURT: Does he have a Georgia driver's license?

DEFENDANT WALDROP: No, Your Honor. South Carolina.

1
2
3
4
5
6
7
8
9
10
11
12
13
14
15
16
17
18
19
20
21
22
23
24
25

MR. BALLARD: Which should be suspended at this point. Your Honor, the reason I bring up that he hasn't driven is this has affected him to that extent that he's afraid to even drive a car.

THE COURT: Let me hear from you, Mr. Waldrop.

DEFENDANT WALDROP: Yes, Your Honor.

THE COURT: Anything you want to say?

DEFENDANT WALDROP: Yes. While I'm here and have this mic, I just want to formally say to Mr. Jones' family, friends, co-workers, anybody else that he left behind, just how truly sorry I am for this accident. And I -- I heard a quote the other day that's been ringing true with me. You need to remember people out loud. Because if you don't, they die twice. So I just want it to be known that for the rest of my life, no matter what happens, no matter what's decided, until I die I'm going to be remembering Mr. Jones out loud and I truly am deeply sorry to anybody here who was a part of his life. Thank you, Your Honor.

THE COURT: It's a tragedy. All right. I'm going to sentence you in accordance with the plea bargain. On Count 1, homicide by vehicle in the second degree, under 17-10-3, which provides for misdemeanor punishment, 12 months probation, \$1,000 fine, 40 hours of community service, completion of a Georgia Department of Driver

1 Services approved defensive driving course. Count 2, 12
2 months consecutive probation, \$500 fine plus surcharges.
3 Total of 24 months. And you will have to report in
4 person. You understand?

5 DEFENDANT WALDROP: Yes. Yes, Your Honor.

6 THE COURT: All right. We'll get that sentence
7 printed up and I'll make it the order of the Court after
8 you've gone over it with your lawyer and signed it.

9 MR. BALLARD: Your Honor, that concludes my business
10 with the Court. May I be excused after we sign the plea?

11 THE COURT: Well, after you've gone over it -- the
12 sentence and made sure I did it right, then you're free to
13 go. Thank you.

14 MR. BALLARD: Thank you.

15 THE COURT: Yes sir.

16 DEFENDANT WALDROP: Thank you.

17 [The Court takes up other unrelated matters.]

18 THE COURT: Mr. Ballard?

19 MR. BALLARD: Yes, Your Honor.

20 THE COURT: Can I help you?

21 MR. BALLARD: Your Honor, may I -- if I could address
22 the Court briefly.

23 THE COURT: Yeah.

24 MR. BALLARD: Mr. Waldrop is a resident of South
25 Carolina.

1
2
3
4
5
6
7
8
9
10
11
12
13
14
15
16
17
18
19
20
21
22
23
24
25

THE COURT: Right.

MR. BALLARD: He drove here. The general conditions of probation prevent him from leaving the state. And so we just wanted to bring that to the Court's attention.

THE COURT: I'm sorry. The general conditions of --

MR. BALLARD: Yes, Your Honor.

THE COURT: -- prevent him from leaving the state of Georgia?

MR. BALLARD: Yes, Your Honor. I think it's about two-thirds of the way through the paragraph there under general conditions.

THE COURT: Right. No, I'm not -- I'm not banning him from -- I mean, if he's a non-resident --

MR. BALLARD: Yeah, and I'm sure --

THE COURT: But since it's a -- it's a misdemeanor. But since it's homicide by vehicle, then I want him to report in person.

MR. BALLARD: Yes, Your Honor.

THE COURT: Where is it -- where is it?

MR. BALLARD: It's about two-thirds of the way through that paragraph, Your Honor.

THE COURT: Which paragraph?

MR. BALLARD: I think it's -- the one that addresses general conditions.

THE COURT: Oh, yeah.

1
2
3
4
5
6
7
8
9
10
11
12
13
14
15
16
17
18
19
20

MR. BALLARD: I'm sorry, Your Honor.

THE COURT: No. I appreciate you looking at it.

MR. BALLARD: Discusses him leaving the jurisdiction of the Court as well as the state of Georgia.

THE COURT: Where is that, Ms. -- let me see. Ms. Bennett, will you show me where that provision is? I'm sorry.

CLERK: It is right here under 6 of the general conditions. Do you maybe just want to mark out --

THE COURT: All right. I've taken that out. Is that the only thing?

MR. BALLARD: It is, Your Honor.

THE COURT: All right. I'll just go ahead and sign this. All right.

MR. BALLARD: Your Honor, does Mr. Waldrop need to report to probation downstairs on the first floor?

THE COURT: Yes sir.

MR. BALLARD: Thank you, Your Honor.

THE COURT: Thank you.

[Proceeding is concluded.]

CERTIFICATE

STATE OF GEORGIA

COUNTY OF JACKSON

I, Misti H. Colley, Certified Court Reporter, -2516, hereby certify that the foregoing pages numbered 2 through 20 constitute a true, complete and accurate transcript of guilty plea in the case of State v. Luke Harrison Waldrop, heard before the Honorable Lawton E. Stephens, Judge of the Superior Courts of the Western Judicial Circuit, Athens-Clarke County Case No. SU-23-CR-0477-S, taken down by me and transcribed under my supervision to the best of my ability.

I further certify that I am a disinterested party to this action and that I am neither of kin nor counsel to any of the parties hereto.

This certification is expressly withdrawn and denied upon disassembly, photocopying, or duplication in any manner or upon certification of the foregoing transcript or any part thereof by any person or entity other than by me. This certification is further expressly withdrawn and denied absent my original signature and original seal appearing hereon below.

In witness whereof, I hereby affix my hand on this the 24th day of October, 2023.

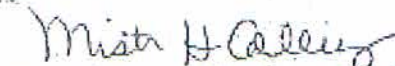
Misti H. Colley, CCR-2516

CC 187

Agency Case Number 2022-03030287		Agency NCIC Number GA0290100		GEORGIA MOTOR VEHICLE CRASH REPORT				Clarke County		Date Rec'd by GDOT													
Estimated Crash Date: 03/03/2022 Time: 23:06		Dispatch Date: 03/03/2022 Time: 23:06		Arrival Date: 03/03/2022 Time: 23:14		Total Number of Vehicles: 2 Injuries: 0 Fatalities: 1		Inside City Of Athens															
Road of Occurrence: TALLASSEE RD				At Its Intersection With: WESTCHESTER DR				<input type="checkbox"/> Corrected Report															
Not At Its Intersection But: <input type="checkbox"/> Miles <input type="checkbox"/> North <input type="checkbox"/> East <input type="checkbox"/> Feet <input type="checkbox"/> South <input type="checkbox"/> West				Of: _____				<input type="checkbox"/> Sup To Original															
Latitude (Y): 33.966599994 (Format) 00.00000				Longitude (X): -83.433366319 (Format) -00.00000				<input type="checkbox"/> Hit and Run															
Unit # 01		<input checked="" type="checkbox"/> Driver <input type="checkbox"/> Ped <input type="checkbox"/> Bike		LAST NAME Waldrop, Luke		FIRST MIDDLE		Unit # 02		<input type="checkbox"/> Driver <input type="checkbox"/> Ped <input checked="" type="checkbox"/> Bike		LAST NAME JONES, JAMES VIVEAN		FIRST MIDDLE									
<input checked="" type="checkbox"/> Susp At Fault		Address 640 Skinner RD		<input type="checkbox"/> Susp At Fault		Address 489 VAUGHN RD																	
City Campobello		State SC		Zip 29322		DOB 1996		City ATHENS		State GA		Zip 30606		DOB 1954									
Driver's License No.		Class C		State SC		Country UNITED STATES		Driver's License No. 059552257		Class C		State GA		Country UNITED STATES									
Insurance Co. None on file		Policy No. N/A		Telephone No.				Insurance Co. No Insurance		Policy No. N/A		Telephone No.											
Year 2020		Make Honda		Model ACCORD				Year		Make		Model											
VIN 1HGEV1F3XLA024795		Vehicle Color White						VIN		Vehicle Color Teal													
Tag # SFF494		State SC		County		Year 2022		Tag #		State		County		Year									
Trailer Tag #		State		County		Year		Trailer Tag #		State		County		Year									
<input type="checkbox"/> Same as Driver		Owner's Last Name Deal, Shannon Noelle		First Middle				<input checked="" type="checkbox"/> Same as Driver		Owner's Last Name		First Middle											
Address 1042 Mt Lebanon RD		City Campobello		State SC		Zip 29322		Address		City		State		Zip									
Removed By: Barrett's Towing		<input type="checkbox"/> Request <input checked="" type="checkbox"/> List						Removed By:		<input type="checkbox"/> Request <input type="checkbox"/> List													
Alco Test: 3		Type:		Results:		Drug Test: 3		Type:		Results:		Alco Test: 2		Type:		Results:		Drug Test: 2		Type:		Results:	
First Harmful Event: 7		Most Harmful Event: 7		Operator/Ped Cond: 4				First Harmful Event: 11		Most Harmful Event: 11		Operator/Ped Cond: 1											
Operator Contributing Factors: 26		17		2				Operator Contributing Factors: 1															
Vehicle Contributing Factors: 1		Roadway Contributing Factors: 1						Vehicle Contributing Factors: 1		Roadway Contributing Factors: 1													
Direction of Travel: 4		Vehicle Maneuver: 5		Non-Motor Maneuver:				Direction of Travel: 4		Vehicle Maneuver: 5		Non-Motor Maneuver:											
Vehicle Class: 1		Vehicle Type: 1		Vision Obscured: 1				Vehicle Class: 1		Vehicle Type:		Vision Obscured: 1											
Number of Occupants: 1		Area of Initial Contact: 1		Damage to Veh: 3				Number of Occupants: 1		Area of Initial Contact: 6		Damage to Veh: 4											
Traffic-Way Flow: 1		Road Comp: 2		Road Character: 2				Traffic-Way Flow: 1		Road Comp: 2		Road Character: 2											
Number of Lanes: 3		Posted Speed: 45		Work Zone: 0				Number of Lanes: 3		Posted Speed: 45		Work Zone: 0											
Traffic Control: 7		Device Inoperative: <input type="checkbox"/> Yes <input checked="" type="checkbox"/> No						Traffic Control: 7		Device Inoperative: <input type="checkbox"/> Yes <input checked="" type="checkbox"/> No													
Citation Information:		Citation # _____		O.C.G.A. § 40-6-391(a)(1)				Citation Information:		Citation # _____		O.C.G.A. § _____											
		Citation # _____		O.C.G.A. § 40-6-393 (a)						Citation # _____		O.C.G.A. § _____											
		Citation # _____		O.C.G.A. § 40-6-58						Citation # _____		O.C.G.A. § _____											
COMMERCIAL MOTOR VEHICLES ONLY																							
Carrier Name:						Carrier Name:																	
Address:						Address:																	
U.S. D.O.T. #		No. of Axles		G.V.W.R.		U.S. D.O.T. #		No. of Axles		G.V.W.R.													
Cargo Body Type		Vehicle Config.		<input type="checkbox"/> Interstate <input type="checkbox"/> Intrastate		Fed. Reportable <input type="checkbox"/> Yes <input type="checkbox"/> No		Cargo Body Type		Vehicle Config.		<input type="checkbox"/> Interstate <input type="checkbox"/> Intrastate		Fed. Reportable <input type="checkbox"/> Yes <input type="checkbox"/> No									
C.D.L.?		<input type="checkbox"/> Yes <input type="checkbox"/> No		C.D.L. Suspended?		<input type="checkbox"/> Yes <input type="checkbox"/> No		C.D.L.?		<input type="checkbox"/> Yes <input type="checkbox"/> No		C.D.L. Suspended?		<input type="checkbox"/> Yes <input type="checkbox"/> No									
Vehicle Placarded?		<input type="checkbox"/> Yes <input type="checkbox"/> No		Hazardous Materials?		<input type="checkbox"/> Yes <input type="checkbox"/> No		Vehicle Placarded?		<input type="checkbox"/> Yes <input type="checkbox"/> No		Hazardous Materials?		<input type="checkbox"/> Yes <input type="checkbox"/> No									
Haz Mat Released?		<input type="checkbox"/> Yes <input type="checkbox"/> No						Haz Mat Released?		<input type="checkbox"/> Yes <input type="checkbox"/> No													
If YES: Name or four Digit Number from Diamond or Box: _____						If YES: Name or four Digit Number from Diamond or Box: _____																	
One Digit Number from Bottom of Diamond: _____						One Digit Number from Bottom of Diamond: _____																	
<input type="checkbox"/> Ran Off Road <input type="checkbox"/> Down Hill Runaway <input type="checkbox"/> Cargo Loss or Shift <input type="checkbox"/> Separation of Units						<input type="checkbox"/> Ran Off Road <input type="checkbox"/> Down Hill Runaway <input type="checkbox"/> Cargo Loss or Shift <input type="checkbox"/> Separation of Units																	

EXHIBIT
M-5

Printed, 3/18/2022 AT 8:31:50 AM BY IVEYA

COLLISION FIELDS

Manner of Collision: 6	Location at Area of Impact: 1	Weather: 1	Surface Condition: 1	Light Condition: 5
------------------------	-------------------------------	------------	----------------------	--------------------

NARRATIVE

Driver 2 was pedaling his bicycle along the right side of the westbound travel lane on Tallassee Rd approaching its intersection with Westchester Dr. Vehicle 1 approached the bicycle from the rear and did not provide enough space to safely negotiate around the bicycle. Vehicle 1 struck the rear of the bicycle with its front passenger corner. Driver 2 came to rest on the shoulder of the roadway. The bicycle came to rest in a roadside ditch not far from Driver 2's location.

The bicycle had a working headlight, and a flashing red LED light facing the rear. Driver 2 was also wearing bright yellow clothing and wearing a helmet at the time of the crash.

Driver 2 was transported to PARMC by ambulance, but did not survive.

DIAGRAM

INDICATE NORTH

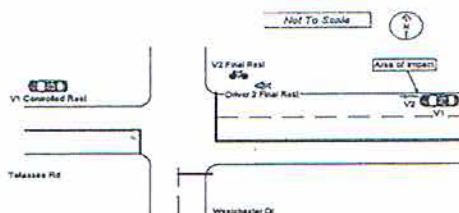

PROPERTY DAMAGE INFORMATION

Damage Other Than Vehicle: _____ Owner: _____

WITNESS INFORMATION

Name (Last, First)	Address	City	State	Zip Code	Telephone Number

OCCUPANT INFORMATION

1	Name (Last, First): Waldrop, Luke					Address: 640 Skinner RD Campobello SC 29322				
	Age: 25	Sex: M	Unit #: 01	Position: 1	Safety Eq: 3	Ejected: 5	Extricated: 2	Air Bag: 2	Injury: 0	Taken for Treatment: 2
	Injured Taken To:		By:		EMS Notified Time:	EMS Arrival Time:	Hospital Arrival Time:			
2	Name (Last, First): JONES, JAMES					Address: 489 VAUGHN RD ATHENS GA 30606				
	Age: 67	Sex: M	Unit #: 02	Position: 1	Safety Eq: 7	Ejected: 3	Extricated: 2	Air Bag: 0	Injury: 1	Taken for Treatment: 1
	Injured Taken To: Piedmont Athens Regional		By: Ambulance		EMS Notified Time: 23:16	EMS Arrival Time: 23:20	Hospital Arrival Time: 23:40			
3	Name (Last, First):					Address:				
	Age:	Sex:	Unit #	Position:	Safety Eq:	Ejected:	Extricated:	Air Bag:	Injury:	Taken for Treatment:
	Injured Taken To:		By:		EMS Notified Time:	EMS Arrival Time:	Hospital Arrival Time:			
4	Name (Last, First):					Address:				
	Age:	Sex:	Unit #	Position:	Safety Eq:	Ejected:	Extricated:	Air Bag:	Injury:	Taken for Treatment:
	Injured Taken To:		By:		EMS Notified Time:	EMS Arrival Time:	Hospital Arrival Time:			

ADMINISTRATIVE

Photos Taken: <input checked="" type="checkbox"/> Yes <input type="checkbox"/> No	By: OFC Compton	Officer Note: If collision resulted in a fatality, please send prompt notification to the GDOT Crash Reporting Unit via either email at GeorgiaFARS@dpt.ga.gov or Fax at (404) 636-2963.			
Report By: Wood, Michael	Agency: Athens-Clarke PD	Report Date: 03/04/2022	Checked By: Wood, Michael	Date Checked: 03/04/2022	

**SUPPLEMENT
GEORGIA MOTOR VEHICLE CRASH REPORT**

Agency Case Number:
2022-03030287

Estimated Crash Date:
03/03/2022

Officer Name:
Wood, Michael

NARRATIVE CONTINUED

Driver 1 was determined to be under the influence of at the time of the crash. After the DUI investigation was concluded, he was arrested and transported to the Clarke County jail where he was issued citations for DUI, Vehicular homicide 1st degree, and failure to provide clearance when passing a bicycle.

The bicycle was a Salsa brand, unknown model or serial number.

I was called in to investigate this crash, and did not have my AXON camera.

ADDITIONAL CITATION INFORMATION

Unit # _____:	Unit # _____:
Citation # _____ O.C.G.A. § _____	Citation # _____ O.C.G.A. § _____
Citation # _____ O.C.G.A. § _____	Citation # _____ O.C.G.A. § _____
Citation # _____ O.C.G.A. § _____	Citation # _____ O.C.G.A. § _____
Citation # _____ O.C.G.A. § _____	Citation # _____ O.C.G.A. § _____
Citation # _____ O.C.G.A. § _____	Citation # _____ O.C.G.A. § _____
Citation # _____ O.C.G.A. § _____	Citation # _____ O.C.G.A. § _____
Citation # _____ O.C.G.A. § _____	Citation # _____ O.C.G.A. § _____

ADDITIONAL OCCUPANT INFORMATION

Name (Last, First):					Address:				
Age:	Sex:	Unit #	Position:	Safety Eq:	Ejected:	Extricated:	Air Bag:	Injury:	Taken for Treatment:
Injured Taken To:		By:		EMS Notified Time:	EMS Arrival Time:		Hospital Arrival Time:		

Name (Last, First):					Address:				
Age:	Sex:	Unit #	Position:	Safety Eq:	Ejected:	Extricated:	Air Bag:	Injury:	Taken for Treatment:
Injured Taken To:		By:		EMS Notified Time:	EMS Arrival Time:		Hospital Arrival Time:		

Name (Last, First):					Address:				
Age:	Sex:	Unit #	Position:	Safety Eq:	Ejected:	Extricated:	Air Bag:	Injury:	Taken for Treatment:
Injured Taken To:		By:		EMS Notified Time:	EMS Arrival Time:		Hospital Arrival Time:		

Name (Last, First):					Address:				
Age:	Sex:	Unit #	Position:	Safety Eq:	Ejected:	Extricated:	Air Bag:	Injury:	Taken for Treatment:
Injured Taken To:		By:		EMS Notified Time:	EMS Arrival Time:		Hospital Arrival Time:		

Name (Last, First):					Address:				
Age:	Sex:	Unit #	Position:	Safety Eq:	Ejected:	Extricated:	Air Bag:	Injury:	Taken for Treatment:
Injured Taken To:		By:		EMS Notified Time:	EMS Arrival Time:		Hospital Arrival Time:		

Agency Case Number 2022-03030287		Agency NCIC Number GA0290100		GEORGIA MOTOR VEHICLE CRASH REPORT				Clarke County			Date Rec. by GDOT
Estimated Crash Date: 03/03/2022 Time: 23:06		Dispatch Date: 03/03/2022 Time: 23:06		Arrival Date: 03/03/2022 Time: 23:14		Total Number of Vehicles: 2 Injuries: 0 Fatalities: 1			Inside City Of Athens		
Road of Occurrence: TALLASSEE RD						At Its Intersection With: WESTCHESTER DR			<input type="checkbox"/> Corrected Report		
Not At Its Intersection But: <input type="checkbox"/> Miles <input type="checkbox"/> North <input type="checkbox"/> East <input type="checkbox"/> Feet <input type="checkbox"/> South <input type="checkbox"/> West						Of: _____			<input checked="" type="checkbox"/> Sup To Original		
Latitude (Y) (Format): 33.966599994 00.00000						Longitude (X) (Format): -83.433366319 -00.00000			<input type="checkbox"/> Hit and Run		
Unit #	<input type="checkbox"/> Driver <input type="checkbox"/> Ped <input type="checkbox"/> Bike	LAST NAME	FIRST	MIDDLE	Unit #	<input type="checkbox"/> Driver <input type="checkbox"/> Ped <input type="checkbox"/> Bike	LAST NAME	FIRST	MIDDLE		
<input type="checkbox"/> Susp At Fault		Address			<input type="checkbox"/> Susp At Fault		Address				
City	State	Zip	DOB		City	State	Zip	DOB			
Driver's License No.	Class	State	Country		Driver's License No.	Class	State	Country			
Insurance Co.	Policy No.	Telephone No.			Insurance Co.	Policy No.	Telephone No.				
Year	Make	Model				Year	Make	Model			
VIN	Vehicle Color					VIN	Vehicle Color				
Tag #	State	County	Year		Tag #	State	County	Year			
Trailer Tag #	State	County	Year		Trailer Tag #	State	County	Year			
<input type="checkbox"/> Same as Driver	Owner's Last Name	First	Middle		<input type="checkbox"/> Same as Driver	Owner's Last Name	First	Middle			
Address						Address					
City	State	Zip			City	State	Zip				
Removed By: <input type="checkbox"/> Request <input type="checkbox"/> List						Removed By: <input type="checkbox"/> Request <input type="checkbox"/> List					
Alco Test	Type	Results	Drug Test	Type	Results	Alco Test	Type	Results	Drug Test	Type	Results
First Harmful Event:		Most Harmful Event:		Operator/Ped Cond:		First Harmful Event:		Most Harmful Event:		Operator/Ped Cond:	
Operator Contributing Factors: _____						Operator Contributing Factors: _____					
Vehicle Contributing Factors:			Roadway Contributing Factors:			Vehicle Contributing Factors:			Roadway Contributing Factors:		
Direction of Travel:	Vehicle Maneuver:	Non-Motor Maneuver:				Direction of Travel:	Vehicle Maneuver:	Non-Motor Maneuver:			
Vehicle Class:	Vehicle Type:	Vision Obscured:				Vehicle Class:	Vehicle Type:	Vision Obscured:			
Number of Occupants:	Area of Initial Contact:	Damage to Veh:				Number of Occupants:	Area of Initial Contact:	Damage to Veh:			
Traffic-Way Flow:	Road Comp:	Road Character:				Traffic-Way Flow:	Road Comp:	Road Character:			
Number of Lanes:	Posted Speed:	Work Zone:				Number of Lanes:	Posted Speed:	Work Zone:			
Traffic Control: Device Inoperative: <input type="checkbox"/> Yes <input type="checkbox"/> No						Traffic Control: Device Inoperative: <input type="checkbox"/> Yes <input type="checkbox"/> No					
Citation Information:						Citation Information:					
Citation # _____		O.C.G.A. § _____				Citation # _____		O.C.G.A. § _____			
Citation # _____		O.C.G.A. § _____				Citation # _____		O.C.G.A. § _____			
Citation # _____		O.C.G.A. § _____				Citation # _____		O.C.G.A. § _____			
COMMERCIAL MOTOR VEHICLES ONLY											
Carrier Name: _____						Carrier Name: _____					
Address		City	State	Zip			Address		City	State	Zip
U.S. D.O.T. #		No. of Axles	G.V.W.R.				U.S. D.O.T. #		No. of Axles	G.V.W.R.	
Cargo Body Type	Vehicle Config.	<input type="checkbox"/> Interstate <input type="checkbox"/> Intrastate	<input type="checkbox"/> Fed. Reportable <input type="checkbox"/> Yes <input type="checkbox"/> No				Cargo Body Type	Vehicle Config.	<input type="checkbox"/> Interstate <input type="checkbox"/> Intrastate	<input type="checkbox"/> Fed. Reportable <input type="checkbox"/> Yes <input type="checkbox"/> No	
C.D.L.?	<input type="checkbox"/> Yes <input type="checkbox"/> No	C.D.L. Suspended?	<input type="checkbox"/> Yes <input type="checkbox"/> No				C.D.L.?	<input type="checkbox"/> Yes <input type="checkbox"/> No	C.D.L. Suspended?	<input type="checkbox"/> Yes <input type="checkbox"/> No	
Vehicle Placarded?	<input type="checkbox"/> Yes <input type="checkbox"/> No	Hazardous Materials?	<input type="checkbox"/> Yes <input type="checkbox"/> No				Vehicle Placarded?	<input type="checkbox"/> Yes <input type="checkbox"/> No	Hazardous Materials?	<input type="checkbox"/> Yes <input type="checkbox"/> No	
Haz Mat Released? <input type="checkbox"/> Yes <input type="checkbox"/> No						Haz Mat Released? <input type="checkbox"/> Yes <input type="checkbox"/> No					
If YES: Name or four Digit Number from Diamond or Box: _____						If YES: Name or four Digit Number from Diamond or Box: _____					
One Digit Number from Bottom of Diamond: _____						One Digit Number from Bottom of Diamond: _____					
<input type="checkbox"/> Ran Off Road <input type="checkbox"/> Down Hill Runaway <input type="checkbox"/> Cargo Loss or Shift <input type="checkbox"/> Separation of Units						<input type="checkbox"/> Ran Off Road <input type="checkbox"/> Down Hill Runaway <input type="checkbox"/> Cargo Loss or Shift <input type="checkbox"/> Separation of Units					

COLLISION FIELDS

Manner of Collision: 6	Location at Area of Impact: 1	Weather: 1	Surface Condition: 1	Light Condition: 5
------------------------	-------------------------------	------------	----------------------	--------------------

NARRATIVE

On March 3, 2022, around 11:40 pm, I received a call from my supervisor, Sgt. Wood in reference to assisting with a fatality wreck involving a vehicle vs. a bicyclist. The location of the collision on Tallassee Rd just south of Westchester Dr. Being called in from an off-duty status, I was not equipped with my department body camera (Axon).

I was informed by Sgt. Wood that patrol officers met with Luke Waldrop who was driving a white Honda Accord and was still on the scene who displayed physical manifestations of alcohol impairment such as bloodshot watery eyes, thick slurred speech, and swaying back and forth as he was talking with officers. The bicyclist was transported by EMS to PARMC where he was pronounced dead from injuries he sustained from the collision.

Upon my arrival, I met with Sgt. Wood. He advised the Honda that was driven by Waldrop who driving northbound on

DIAGRAM

INDICATE NORTH



PROPERTY DAMAGE INFORMATION

Damage Other Than Vehicle:	Owner:
----------------------------	--------

WITNESS INFORMATION

Name (Last, First)	Address	City	State	Zip Code	Telephone Number
--------------------	---------	------	-------	----------	------------------

OCCUPANT INFORMATION

Name (Last, First):		Address:								
1	Age:	Sex:	Unit #	Position:	Safety Eq:	Ejected:	Extricated:	Air Bag:	Injury:	Taken for Treatment:
Injured Taken To:		By:			EMS Notified Time	EMS Arrival Time	Hospital Arrival Time			
Name (Last, First):		Address:								
2	Age:	Sex:	Unit #	Position:	Safety Eq:	Ejected:	Extricated:	Air Bag:	Injury:	Taken for Treatment:
Injured Taken To:		By:			EMS Notified Time	EMS Arrival Time	Hospital Arrival Time			
Name (Last, First):		Address:								
3	Age:	Sex:	Unit #	Position:	Safety Eq:	Ejected:	Extricated:	Air Bag:	Injury:	Taken for Treatment:
Injured Taken To:		By:			EMS Notified Time	EMS Arrival Time	Hospital Arrival Time			
Name (Last, First):		Address:								
4	Age:	Sex:	Unit #	Position:	Safety Eq:	Ejected:	Extricated:	Air Bag:	Injury:	Taken for Treatment:
Injured Taken To:		By:			EMS Notified Time	EMS Arrival Time	Hospital Arrival Time			

ADMINISTRATIVE

Photos Taken: <input checked="" type="checkbox"/> Yes <input type="checkbox"/> No	By: OFC Compton	<i>Officer Note: If collision resulted in a fatality, please send prompt notification to the GDOT Crash Reporting Unit via either email at GeorgiaFARS@gdot.ga.gov or Fax at (404) 635-2963.</i>			
Report By: Lewis, Joey	Agency: Athens-Clarke PD	Report Date: 03/04/2022	Checked By: Wood, Michael	Date Checked: 03/10/2022	

**SUPPLEMENT
GEORGIA MOTOR VEHICLE CRASH REPORT**

Agency Case Number:
2022-03030287

Estimated Crash Date:
03/03/2022

Officer Name:
Lewis, Joey

NARRATIVE CONTINUED

Tallassee Rd and struck a bicyclist who was also northbound on Tallassee Rd just south of Westchester Dr. The bicyclist was wearing a typical road bicycle suit that consisted of a bright yellow top and had a red LED light attached to the rear of the bicycle still blinking as we investigated. The bicycle also had a front headlight on the bicycle and was still illuminating. The collision caused the bicyclist to become ejected from the bicycle and his body struck the windshield of the Honda. This collision then redirected his body to fly off the windshield and land in the ditch on the northeast shoulder of Tallassee Rd.

Sgt. Wood told me to assist SPO Denmark with the investigation with the driver of the Honda. SPO Denmark and I met with Waldrop and I observed he was displaying physical manifestations of alcohol impairment such as bloodshot watery eyes, thick slurred speech and he was swaying back and forth and side by side as he stood. Waldrop stated he was coming from downtown Athens and was heading home which is off Vaughn Rd. Waldrop stated he consumed three beers not too long ago. SPO Denmark furthered an impairment investigation by asking Waldrop if he would be willing to participate in SFST to which Waldrop said "yes." This was based on the collision, Waldrop's physical manifestations of alcohol impairment he was exhibiting.

Horizontal Gaze Nystagmus:

I stood directly behind SPO Denmark and observed the test over SPO Denmark's right shoulder. Waldrop was not wearing glasses. He was not wearing contacts. He stated he didn't any head injuries. His pupils were equal in size. His eyes tracked equally. No resting nystagmus was present. He swayed during the test. I observed the following clues as SPO Denmark administered the test:

ADDITIONAL CITATION INFORMATION

Unit # _____:	Unit # _____:
Citation # _____ O.C.G.A. § _____	Citation # _____ O.C.G.A. § _____
Citation # _____ O.C.G.A. § _____	Citation # _____ O.C.G.A. § _____
Citation # _____ O.C.G.A. § _____	Citation # _____ O.C.G.A. § _____
Citation # _____ O.C.G.A. § _____	Citation # _____ O.C.G.A. § _____
Citation # _____ O.C.G.A. § _____	Citation # _____ O.C.G.A. § _____
Citation # _____ O.C.G.A. § _____	Citation # _____ O.C.G.A. § _____
Citation # _____ O.C.G.A. § _____	Citation # _____ O.C.G.A. § _____

ADDITIONAL OCCUPANT INFORMATION

Name (Last, First):					Address:				
Age:	Sex:	Unit #	Position:	Safety Eq:	Ejected:	Extricated:	Air Bag:	Injury:	Taken for Treatment:
Injured Taken To:		By:		EMS Notified Time:		EMS Arrival Time:		Hospital Arrival Time:	
Name (Last, First):					Address:				
Age:	Sex:	Unit #	Position:	Safety Eq:	Ejected:	Extricated:	Air Bag:	Injury:	Taken for Treatment:
Injured Taken To:		By:		EMS Notified Time:		EMS Arrival Time:		Hospital Arrival Time:	
Name (Last, First):					Address:				
Age:	Sex:	Unit #	Position:	Safety Eq:	Ejected:	Extricated:	Air Bag:	Injury:	Taken for Treatment:
Injured Taken To:		By:		EMS Notified Time:		EMS Arrival Time:		Hospital Arrival Time:	
Name (Last, First):					Address:				
Age:	Sex:	Unit #	Position:	Safety Eq:	Ejected:	Extricated:	Air Bag:	Injury:	Taken for Treatment:
Injured Taken To:		By:		EMS Notified Time:		EMS Arrival Time:		Hospital Arrival Time:	
Name (Last, First):					Address:				
Age:	Sex:	Unit #	Position:	Safety Eq:	Ejected:	Extricated:	Air Bag:	Injury:	Taken for Treatment:
Injured Taken To:		By:		EMS Notified Time:		EMS Arrival Time:		Hospital Arrival Time:	

**SUPPLEMENT
GEORGIA MOTOR VEHICLE CRASH REPORT**

Agency Case Number:
2022-03030287

Estimated Crash Date:
03/03/2022

Officer Name:
Lewis, Joey

NARRATIVE CONTINUED

The lack of smooth pursuit in both of his eyes.
Distinct and sustained nystagmus at maximum deviation in both of his eyes.
The onset of nystagmus prior to 45 degrees in both of his eyes.
Vertical gaze nystagmus was present in both of his eyes.

A total of 6/6 clues were observed.

Walk and Turn Test:

Waldrop was wearing tennis shoes. He stated he understood the test and did not have any problems walking in a straight line. I observed the following clues as SPO Denmark administered:

He was unable to maintain balance while listening to instructions and broke the instruction stance multiple times.
He used his arms for balance while walking down and back.
Missed heel to toe multiple times.
He stepped offline.
He made an improper turn. He spun around on his left heel and lost his balance.

A total of 5/8 clues were observed.

One Leg Stand:

During this test, Waldrop stood on his left leg and raised his right. I observed the following clue as SPO Denmark

ADDITIONAL CITATION INFORMATION

Unit # _____:	Unit # _____:
Citation # _____ O.C.G.A. § _____	Citation # _____ O.C.G.A. § _____
Citation # _____ O.C.G.A. § _____	Citation # _____ O.C.G.A. § _____
Citation # _____ O.C.G.A. § _____	Citation # _____ O.C.G.A. § _____
Citation # _____ O.C.G.A. § _____	Citation # _____ O.C.G.A. § _____
Citation # _____ O.C.G.A. § _____	Citation # _____ O.C.G.A. § _____
Citation # _____ O.C.G.A. § _____	Citation # _____ O.C.G.A. § _____
Citation # _____ O.C.G.A. § _____	Citation # _____ O.C.G.A. § _____

ADDITIONAL OCCUPANT INFORMATION

Name (Last, First):					Address:				
Age:	Sex:	Unit #	Position:	Safety Eq:	Ejected:	Extricated:	Air Bag:	Injury:	Taken for Treatment:
Injured Taken To:		By:		EMS Notified Time		EMS Arrival Time		Hospital Arrival Time	
Name (Last, First):					Address:				
Age:	Sex:	Unit #	Position:	Safety Eq:	Ejected:	Extricated:	Air Bag:	Injury:	Taken for Treatment:
Injured Taken To:		By:		EMS Notified Time		EMS Arrival Time		Hospital Arrival Time	
Name (Last, First):					Address:				
Age:	Sex:	Unit #	Position:	Safety Eq:	Ejected:	Extricated:	Air Bag:	Injury:	Taken for Treatment:
Injured Taken To:		By:		EMS Notified Time		EMS Arrival Time		Hospital Arrival Time	
Name (Last, First):					Address:				
Age:	Sex:	Unit #	Position:	Safety Eq:	Ejected:	Extricated:	Air Bag:	Injury:	Taken for Treatment:
Injured Taken To:		By:		EMS Notified Time		EMS Arrival Time		Hospital Arrival Time	

**SUPPLEMENT
GEORGIA MOTOR VEHICLE CRASH REPORT**

Agency Case Number: 2022-03030287	Estimated Crash Date: 03/03/2022	Officer Name: Lewis, Joey
---	--	-------------------------------------

NARRATIVE CONTINUED

administered:

He swayed during the test.
He raised his arms for balance.
He put his foot down multiple times.

A total of 3/4 clues were observed.

SPO Denmark arrested Waldrop for DUI. SPO Denmark and I escorted Waldrop to the back of SPO Denmark's patrol car where SPO Denmark read him the Georgia Implied Consent Notice for Suspects over the age of 21. SPO Denmark requested a blood test. Waldrop said "No."

We then relocated to the West Precinct where SPO Denmark got a blood search warrant signed. While waiting at the precinct I watch Waldrop while he was in the back of the patrol car passed out. I was sitting in the driver's seat of SPO Denmark's car and the inside of the entire car smelled of an alcoholic beverage. SPO Denmark then transported Waldrop to PARMC for the blood draw. I followed them in my patrol car. Waldrop refused to sign all PARMC documents. The Phlebotomist [redacted] met us in the back where blood draws are performed. Waldrop was made very clear that SPO Denmark had a signed blood search warrant from a judge and Waldrop again refused the blood draw again. Waldrop however signed the phlebotomist's refusal letter (copy of that was retained). Waldrop was transported to the Clarke County Jail and turned over to deputies. Waldrop was charged vehicular homicide 1st degree, DUI less safe, and overtaking and passing a bicyclist.

ADDITIONAL CITATION INFORMATION

Unit # _____	Unit # _____
Citation # _____ O.C.G.A. § _____	Citation # _____ O.C.G.A. § _____
Citation # _____ O.C.G.A. § _____	Citation # _____ O.C.G.A. § _____
Citation # _____ O.C.G.A. § _____	Citation # _____ O.C.G.A. § _____
Citation # _____ O.C.G.A. § _____	Citation # _____ O.C.G.A. § _____
Citation # _____ O.C.G.A. § _____	Citation # _____ O.C.G.A. § _____
Citation # _____ O.C.G.A. § _____	Citation # _____ O.C.G.A. § _____
Citation # _____ O.C.G.A. § _____	Citation # _____ O.C.G.A. § _____

ADDITIONAL OCCUPANT INFORMATION

Name (Last, First):					Address:				
Age:	Sex:	Unit #	Position:	Safety Eq:	Ejected:	Extricated:	Air Bag:	Injury:	Taken for Treatment:
Injured Taken To:		By:		EMS Notified Time:		EMS Arrival Time:		Hospital Arrival Time:	
Name (Last, First):					Address:				
Age:	Sex:	Unit #	Position:	Safety Eq:	Ejected:	Extricated:	Air Bag:	Injury:	Taken for Treatment:
Injured Taken To:		By:		EMS Notified Time:		EMS Arrival Time:		Hospital Arrival Time:	
Name (Last, First):					Address:				
Age:	Sex:	Unit #	Position:	Safety Eq:	Ejected:	Extricated:	Air Bag:	Injury:	Taken for Treatment:
Injured Taken To:		By:		EMS Notified Time:		EMS Arrival Time:		Hospital Arrival Time:	
Name (Last, First):					Address:				
Age:	Sex:	Unit #	Position:	Safety Eq:	Ejected:	Extricated:	Air Bag:	Injury:	Taken for Treatment:
Injured Taken To:		By:		EMS Notified Time:		EMS Arrival Time:		Hospital Arrival Time:	

GEORGIA MOTOR VEHICLE CRASH REPORT OVERLAY



ALCOHOL AND/OR DRUG TEST GIVEN
1-Yes
2-No
3-Refused

TEST TYPE
1-Blood
2-Breath
3-Urine
4-Other

FIRST / MOST HARMIFUL EVENT
<i>Non Collision</i>
1-Overturn
2-Fire/Explosion
3-Immersion
4-Jackknife
5-Other Non-Collision
<i>Collision With Object Not Fixed</i>
6-Pedestrian
7-Pedalcycle
8-Railway Train/Street Car
9-Animal
10-Parked Motor Vehicle
11-Motor Vehicle in Motion
13-Other Object (Not Fixed)
14-Deer
<i>Collision With Fixed Object</i>
15-Impact Attenuator
16-Bridge Pier/Abutment
17-Bridge Parapet End
18-Bridge Rail
19-Guardrail Face
20-Guardrail End
21-Median Barrier
22-Highway Traffic Sign Post
23-Overhead Sign Support
24-Luminaire Light Support
25-Utility Pole
26-Other Post
27-Culvert
28-Curb
29-Ditch
30-Embankment
31-Fence
32-Mailbox
33-Tree
34-Other Fixed Object
37-Bridge Overhead Structure
38-Cable Barrier

OPERATOR/PEDESTRIAN CONDITION
1-Not Drinking
2-Unknown
4-U.I. Alcohol
5-U.I. Drugs
6-U.I. Alcohol & Drugs
7-Physical Impairment
8-Suspected Fatigued or Asleep
9-Emotional (depressed, angry, disturbed, etc.)
10-Suspected U.I. (Alcohol and/or Drugs)

OPERATOR CONTRIBUTING FACTORS
1-No Contributing Factors
2-Under the Influence (U.I.)
3-Following Too Close
4-Failed to Yield
5-Exceeding Speed Limit
6-Disregard Stop Sign/Signal
7-Wrong Side of Road
9-Improper Passing
10-Driver Lost Control
11-Changed Lanes Improperly
12-Reaction to Object or Animal
13-Improper Turn
14-Parked Improperly
17-Misjudged Clearance
18-Improper Backing
19-No Signal/Improper Signal
20-Driver Condition
22-Too Fast for Conditions
23-Improper Passing of School Bus
24-Disregard Police - Traffic Control
26-Other
28-Inattentive or Other Distraction (Distracted)
29-Texing (Distracted)
30-Talking on Hands-Free Device (Distracted)
31-Talking on Hand-Held Device (Distracted)
32-Other Activity-Mobile Device (Distracted)
33-Occupant Distraction (Distracted)
34-Other Interior Distraction (Distracted)
35-Other Exterior Distraction (Distracted)
36-Disregard Other Traffic Control
37-Reckless Driving
38-Aggressive Driving
39-Racing
40-Disregard Police - Evasion
41-Not Visible (Object, Person, or Vehicle)
42-Vision Obscured

VEHICLE CONTRIBUTING FACTORS
1-No Contributing Factors
2-Tire Failure
3-Brake Failure
4-Improper or Inoperative Lights/Signals
5-Steering Failure
6-Slick Tires
7-Other
8-Mirrors
9-Power Train
10-Suspension
11-Truck Coupling/Trailer Hitch/Safety Chains
12-Windows/Windshield
13-Wipers

ROADWAY CONTRIBUTING FACTORS
1-No Contributing Factors
2-Shoulder (none, low, soft, high)
3-Ruts, Holes, Bumps
4-Loose Material On Surface
5-Water Standing
6-Work Zone (construction/maintenance/utility)
8-Other
9-Backup Due to Prior Crash/Secondary Crash
10-Traffic Congestion
11-Road Surface Condition (wet, icy, snow, slush, etc.)
12-Obstruction in Roadway
13-Visual Obstruction(s) - Other Along Roadway
14-Visual Obstruction(s) - Vegetation Along Roadway
15-Incident Response Scene

DIRECTION OF TRAVEL
1-North
2-South
3-East
4-West

VEHICLE MANEUVER
1-Turning Left
2-Turning Right
3-Making U-Turn
4-Stopped
5-Straight
6-Changing Lanes
7-Backing
8-Parked
9-Passing
10-Negotiating a Curve
11-Entering/Leaving Parking
12-Entering/Leaving Driveway
13-PIT
14-Other

NON-MOTORIST MANEUVER
1-Crossing, Not at Crosswalk
2-Crossing at Crosswalk
3-Moving With Traffic on Roadway
4-Moving Against Traffic on Roadway
5-Pushing or Working on Vehicle
6-Other Working in Roadway
7-Playing in Roadway
8-Standing in Roadway
9-Off Roadway
10-Other
11-Darting into Traffic
12-Entering/Exiting Bus
13-Entering/Exiting Parked or Standing Vehicle

VEHICLE CLASS
1-Privately Owned
2-Police
3-Fire
4-School
5-Other Govt. Owned
6-Military
7-Commercial Motor Vehicle (CMV)
8-Other
9-Non-Transport Emergency Services Vehicle/HERO
10-Passenger Service Vehicle (Taxi)

VEHICLE TYPE
1-Passenger Car
2-Pickup Truck
3-Truck Tractor (Bobtail)
4-Tractor/Trailer
5-Tractor W/Twin Trailers
6-Logging Truck
7-Logging Tractor/Trailer
8-Single Unit Truck
9-Panel Truck
10-Van
11-Sports Utility Vehicle (SUV)
12-Vehicle With Trailer
13-Bus
14-Truck Towing House Trailer
15-Ambulance
16-Motorized Recreational Vehicle
17-Motorcycle
18-Moded, Scooter, or Minitbike
19-Pedalcycle or Bicycle
20-Farm or Construction Equip.
21-All Terrain Vehicle (ATV)
22-Other
23-Golf Cart or Go Cart

VISION OBSCURED BY
1-Not Obscured
2-Headlights
3-Sunlight/Glare
4-Parked/Stopped Vehicle
5-Trees, Bushes
6-Rain, Snow, Ice on Windshield
7-Other

AREA OF INITIAL CONTACT
00-Overturned
13-Top
14-Undercarriage
15-Non-Contact Vehicle
16-Not Applicable - Pedestrian

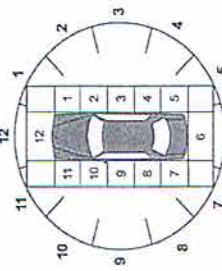
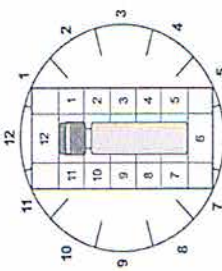
DAMAGE TO VEHICLE
1-No Damage
2-Minor Damage
3-Functional Damage
4-Disabling Damage

TRAFFIC-WAY FLOW
1-Two-way Traffic-way With No Physical Separation
2-Two-way Traffic-way With a Physical Separation
3-Two-way Traffic-way With a Physical Barrier
4-One-way Traffic-way
5-Continuous Turning Lane

ROAD COMPOSITION
1-Concrete
2-Black Top
3-Tar and Gravel
4-Dirt
5-Gravel
6-Other

ROAD CHARACTER
1-Straight and Level
2-Straight on Grade
3-Straight on Hillcrest
4-Curve and Level
5-Curve on Grade
6-Curve on Hillcrest

WORK ZONE
0-None
1-Construction
2-Maintenance
3-Utility
4-Unknown Type

TRAFFIC CONTROL
0-Gate
1-No Control Present
2-Traffic Signal
3-RR Signal/Sign
4-Warning Sign
5-Stop Sign
6-No Passing Zone
7-Lanes
8-Other
9-Flashing Lights
10-Yield Sign

CARGO BODY TYPE
1-Van (Encl. Box)
2-Auto Carrier or Tow Truck
3-Bus
4-Dump
5-Garbage/Refuse
6-Flatbed
7-Cargo Tanker
8-Concrete Mixer
9-Other
10-Hopper
11-Intermodal Container Chassis
12-Pole-Trailer

VEHICLE CONFIGURATION
1-Bus (Seating for More Than 15 Passengers)
2-Single Unit Truck: 2 Axles
3-Single Unit Truck: 3 or More Axles
4-Truck Trailer
5-Truck Tractor (Bobtail)
6-Tractor Trailer
7-Tractor With Twin Trailers
8-Unknown Heavy Truck (Cannot Classify)
9-Bus/Large Van (seats for 9-15 occupants, including driver)
10-Vehicle 10,000 Pounds or Less Placarded for Hazardous Materials

PAGE 2 ATTRIBUTES (SHADED)
MANNER OF COLLISION
1-Angle
2-Head On
3-Rear End
4-Sideswipe - Same Direction
5-Sideswipe - Opposite Direction
6-Not a Collision With a Motor Vehicle

LOCATION AT AREA OF IMPACT
1-On Roadway - Non-Intersection
2-On Shoulder
3-Off Roadway
4-Median
5-Entrance/Exit Ramp
6-Grade
7-On Roadway - Roadway Intersection
8-On Roadway - Roundabout
9-On Roadway - Driveway Intersection
10-On Roadway - Railroad Crossing
11-On Roadway - Managed Lane (HOV, HOT, Reversible)
12-On Roadway - Collector Distributor (CD)
13-On Roadway - Bicycle Lane
14-On Roadway - In Crosswalk
15-Off Roadway - Sidewalk
16-Private Property

WEATHER
1-Clear
2-Cloudy
3-Rain
4-Snow
5-Sleet
6-Fog
7-Other
8-Severe Thunderstorm or Tornado

SURFACE CONDITION
1-Dry
2-Wet
3-Snow
4-Ice/Frost
5-Other
6-Mud
7-Sand
8-Slush
9-Oil
10-Water (standing or moving)

LIGHT CONDITION
1-Daylight
2-Dusk
3-Dawn
4-Dark - Lighted
5-Dark - Not Lighted

AGE
00-Up to One Year
01 to 97-Actual Age
98-Ninety-eight years old or Older
99-Unknown

SEX
M-Male
F-Female

SEATING POSITION
1-Front Seat - Left Side (Operator)
2-Front Seat - Middle
3-Front Seat - Right Side
4-Rear Seat - Left Side
5-Rear Seat - Middle
6-Rear Seat - Right Side
7-Other Seat - Interior
8-Riding on Vehicle Exterior
9-Non-Motorist - Outside of a Vehicle

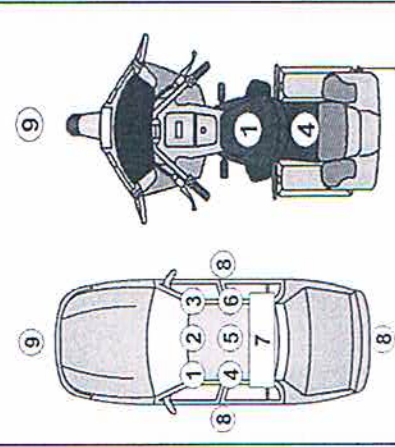

SAFETY EQUIPMENT
0-None Used
1-Shoulder Belt Only Used
2-Lap Belt Only Used
3-Lap and Shoulder Belt Used
4-Child Restraint System (Properly Used)
5-Child Restraint System (Improperly Used)
6-Motorcycle Helmet
7-Bicycle Helmet
8-Unknown
9-Booster Seat (Properly Used)
10-Booster Seat (Improperly Used)
11-Non-Motorist Lighting
12-Reflective: Clothing/Backpack/Equipment

EJECTION
1-Not Ejected
2-Trapped
3-Totally Ejected
4-Partially Ejected
5-Not Applicable

EXTRICATION (Equipment Used)
1-Yes
2-No

AIR BAG FUNCTION
0-No Air Bag in this Seat
1-Deployed Air Bag
2-Non-Deployed Air Bag
3-Deployed Side
4-Deployed other Directions
5-Deployed Multiple Directions
6-Non-Deployed Front
7-Non-Deployed Side
8-Non-Deployed Other Direction
9-Non-Deployed Multiple Directions
10-Deployed Curtain

INJURY
0-No Apparent Injury (O)
1-Fatal Injury (K)
2-Suspected Serious Injury (A)
3-Suspected Minor or Visible Injury (B)
4-Possible Injury or Complaint (C)

TAKEN FOR TREATMENT
1-Yes
2-No

Deborah Gonzalez
District Attorney

Chief ADA
Mikaela Silkey Henderson

Chief Investigator
Felicia Fortson

Director, Victim Services
Tanya Wingfield

Director, External Relations
Jenna Vaisvil

STATE OF GEORGIA



Athens-Clarke County Office
Athens-Clarke County Courthouse
325 E. Washington Street, Rm 370
Athens, Georgia 30601
Telephone: (706) 613-3240
Telefax: (706) 613-3247

Oconee County Office
Oconee County Courthouse
Watkinsville, Georgia 30677
Telephone: (706) 769-3954
Telefax: (706) 769-3977

OFFICE OF THE DISTRICT ATTORNEY
WESTERN JUDICIAL CIRCUIT
Athens-Clarke & Oconee Counties

Writer's Email
Alice.Hayes@accgov.com

Friday, April 15, 2022

Susan Wilson
489 Vaughn Rd
Athens, GA 30606

Defendant(s): Luke Harrison Waldrop
Charges: Homicide By Vehicle In 1st Degree - Felony
Dui - Driving Under The Influence Of Alcohol
Improper Passing of a Bicycle
Case Number: CR-CR-22-1182, CR-CR-22-1183, CR-CR-22-1184

Dear Susan Wilson:

The Victim Witness Program in the office of District Attorney Deborah Gonzalez was created to keep victims and witnesses informed of their rights and responsibilities within the criminal justice system. It is the goal of our office to provide victims and witnesses with information about the courts and other resources available to them. Please review this letter and the enclosed information to learn about your rights and responsibilities.

The Procedural Steps in Processing a Case

For information about the procedural steps in processing a case, please refer to the enclosed sheet 'Tracking a Case Through the Criminal Justice System'. This sheet provides a brief explanation of the court process.

Victim Impact Statement

Enclosed with this letter you will find a Victim Impact Statement. Please complete this statement and return it to us. Please see the Victim Impact Instruction Sheet for details.

What to Do if You Are Subjected to Threats or Intimidation

If you are subjected to threats or intimidation by the defendant or by someone acting on the defendant's behalf, you should call the police immediately and make a full report of the incident.

Your Rights as a Victim

As the victim of a crime you have rights created by Georgia Law. According to the Crime Victim's Bill of Rights, you have the right to be notified of any judicial proceeding at which the release of the accused will be considered. You also have the right to share your opinions about the release of the defendant pending judicial proceedings. In order to invoke these rights, you need only provide a landline

telephone number. If you already provided your correct telephone number to the police, you do not need to contact us to provide it a second time. In addition to this right, you have the right to be notified about all court appearances of the defendant. In order to invoke this right, you must notify us, in writing, of your intention to invoke this right and provide us with your landline telephone number and your current mailing address. After the case is over, you have the right to be notified of any motion for new trial or appeal the defendant may file. In order to invoke this right you must also notify us, in writing, of your intention and once again provide us with your landline telephone number and current mailing address.

Additionally, you have the right to comment on the disposition of this case, including your views on plea or sentence negotiations and whether or not the defendant should have been permitted to participate in pre-trial programs. If you would like to comment on these matters, please include your comments with the enclosed Victim Impact Statement.

Please note that in regard to all of the rights described above, it is your responsibility to maintain contact with this office and notify us of any changes to your telephone number and/or address so that we may send you notifications on a timely manner.

If You Are Needed As A Witness

If the defendant enters a plea of not guilty and the case is set for trial, you will likely be needed as a witness. If you are needed as a witness, you will receive a subpoena from our office telling you the date and time you will be required to attend court. We understand that many people are nervous about testifying and will be happy to discuss your questions or concerns, if any.

Crime Victim Compensation Program

Accompanying this letter you will find information related to the Governor's Crime Victim Compensation Program. If you would like to participate in this program, complete the enclosed forms and return the completed forms to the Office of the Governor. Do not return the Crime Victim Compensation Program materials to us.

No one ever plans to be the victim of a crime, however, when a crime occurs, victims do have rights. Please do not hesitate to contact anyone in the District Attorney's Victim Witness Program with any questions or concerns you may have.

Sincerely,

Alice Hayes
Victim Advocate
Victim Assistance Program

Enclosures



Defendant Luke Harrison Waldrop **DA#** 22CLK00559 **Status** Closed 09/21/2023 **Status Note** PG - 24 months probation - 40 hours comm service - defensive driving course **Court #** SU-23-CR-0477-S
Case # Felony Traffic/Injury **Pros:** Tab Hunter

Next Event: 11/06/2023, Motion Hearing for Luke Harrison Waldrop

- Attributes
- Parties
- Charges
- Events
- Notes
- Victims
- Documents
- Attachments
- Discovery

Victim Stats (Show Witnesses)

Role	Notify	Victim	County	Dem	VSSR	VAWA	Disp.
Victim- Deceased	Y	James Vivean Jones	(Deceased)				
Family Member of Victim	Y	Melody Ann Jones	Out of State	//?	Survivors of Homicide		Pled to Lesser/Lower Category Edit Del
Family Member of Victim	Y	Susan Wilson	Clarke	//?	Survivors of Homicide		Pled to Lesser/Lower Category Edit Del

| Set Notifications | Set Restitution | Set Dispositions

Victim Services Add Service | Add Information/Referral

Victim/Witness	Date	Service	Note	Staff
Susan Wilson	09/25/2023	4 services	Susan called in with more questions for the plea that was accepted on her case. Provided answers that I could. Advised that I would call back with other answers when I get them.	Simona Arroyo Show/Edit
Susan Wilson	09/21/2023	4 services	Called to give result of plea. Offered additional support if needed.	Simona Arroyo Show/Edit
Melody Ann Jones	09/21/2023	4 services	Called to let her know plea results. She is not happy, but understands the legal process has been done.	Simona Arroyo Show/Edit

Susan Wilson	09/21/2023	4 services	TTC partner to give details of plea offer and to notify of upcoming trial LVM	Simona Arroyo	Show/Edit
Melody Ann Jones	09/21/2023	4 services	Called sister to give details of the plea offer and to give information of the upcoming trial. She is totally against the plea offer as it stands and wants the D to have to serve time	Simona Arroyo	Show/Edit
Susan Wilson	09/30/2022	Individual Support	TTC V as she requested - no answer, left vm & texted, per V request	Alice Hayes	Show/Edit
Susan Wilson	09/28/2022	2 services	Rec'd & responded to email from V - see notes	Alice Hayes	Show/Edit
Susan Wilson	08/30/2022	Individual Support	Called V to "check in" - no answer, left vm stating I was calling to check in & see how everything is going, & could V please return my call @ her convenience	Alice Hayes	Show/Edit
Susan Wilson	08/12/2022	2 services	Emailed V list of counseling resources - see notes	Alice Hayes	Show/Edit
Susan Wilson	08/10/2022	4 services	Meeting w/ V (1hr 10mins) to advise on VIS and restitution form; discuss needs/resources (see notes)	Alice Hayes	Show/Edit
Susan Wilson	08/04/2022	Individual Support	Called V to "check in" - see notes. Scheduled appointment w/ V for 8/10/22 @ 9:30	Alice Hayes	Show/Edit
Susan Wilson	07/15/2022	2 services	Rec'd 2 emails from V- see notes; did not respond to emails, called her instead. Sent separate email with possible resources; see notes.	Alice Hayes	Show/Edit
Susan Wilson	07/14/2022	5 services	Emailed copy of initial contact/intake paperwork, per V request	Alice Hayes	Show/Edit
Susan Wilson	07/14/2022	2 services	TC to V, discussed financial needs & possible resources - see notes. Emailed link/referral to Athens Land Trust Homebuyer Education Classes.	Alice Hayes	Show/Edit
Susan Wilson	07/14/2022	Individual Support	TC to V, discussed financial needs & possible resources - see notes. Emailed link/referral to Athens Land Trust Homebuyer Education Classes.	Alice Hayes	Show/Edit
Susan Wilson	07/06/2022	2 services	Emailed V list of financial assistance resources - see notes	Alice Hayes	Show/Edit
Melody Ann Jones	07/06/2022	Individual Support	Sent Piedmont Athens Regional release form to Melody Jones for signature	Alice Hayes	Show/Edit
Susan Wilson	06/30/2022	Individual Support	Called to discuss V's financial needs - V asked if I could call her back Tuesday morning. Advised I will be in trial but Tuesday morning could work- depends on how long jury selection lasts. Will f/u with V.	Alice Hayes	Show/Edit
Melody Ann Jones	06/30/2022	CJS Victim Support & Advocacy	Called to ask Ms. Jones if she could please sign medical release so we can obtain V's records - no answer, left vm asking her to call me back	Alice Hayes	Show/Edit
Susan Wilson	06/27/2022	2 services	Called V - she was teaching class & couldn't talk. Let her know I got her email & responded but we're having server issues; I will re-send ASAP.	Alice Hayes	Show/Edit

Susan Wilson	06/27/2022	5 services	Responded to email from V - email immediately bounced back, we are having internet issues today. Will re-send ASAP.	Alice Hayes	Show/Edit
Melody Ann Jones	06/24/2022	4 services	Notified of Arraignment outcome	Alice Hayes	Show/Edit
Susan Wilson	06/22/2022	4 services	Notified of Arraignment outcome (in person- Ms. Wilson attended Arraignment)	Alice Hayes	Show/Edit
Melody Ann Jones	06/22/2022	CJS Victim Support & Advocacy	Attended court	Alice Hayes	Show/Edit
Susan Wilson	06/22/2022	CJS Victim Support & Advocacy	Attended court with Susan Wilson	Alice Hayes	Show/Edit
Susan Wilson	06/22/2022	CJS Victim Notification	ACC phones are down/cannot receive incoming calls - texted V so she'd have a way to contact me	Alice Hayes	Show/Edit
Susan Wilson	06/21/2022	4 services	Rec'd call from V - discussed what to expect tomorrow (Arraignment)	Alice Hayes	Show/Edit
Susan Wilson	06/17/2022	2 services	V called - wanted to know if she can have a friend accompany her to arraignment for support. Advised that should be fine	Alice Hayes	Show/Edit
Melody Ann Jones	06/14/2022	4 services	Notified of Arraignment via phone (vm) & email	Alice Hayes	Show/Edit
Susan Wilson	06/14/2022	4 services	Notified of Arraignment via phone & email - see notes	Alice Hayes	Show/Edit
Melody Ann Jones	05/23/2022	CJS Victim Support & Advocacy	V returned my call - just wanted to know if she *has to* complete VIS. Would like updates on case but "doesn't need assistance".	Alice Hayes	Show/Edit
Melody Ann Jones	05/23/2022	2 services	See notes	Alice Hayes	Show/Edit
2 victims	05/17/2022	2 services	Attended court	Alice Hayes	Show/Edit
Melody Ann Jones	04/20/2022	4 services	Mailed initial contact packet	Alice Hayes	Show/Edit
Melody Ann Jones	04/20/2022	4 services	TC to V - see notes	Alice Hayes	Show/Edit
Susan Wilson	04/15/2022	2 services	Texted V to confirm email address & contact info for Melody Jones	Alice Hayes	Show/Edit
Susan Wilson	04/15/2022	2 services	Emailed V, per her request - it bounced back undeliverable. Will text instead.	Alice Hayes	Show/Edit
Susan Wilson	04/15/2022	4 services	Mailed initial contact packet	Alice Hayes	Show/Edit
Susan Wilson	04/15/2022	4 services	TC from V - see notes	Alice Hayes	Show/Edit

Susan Wilson	04/15/2022	CJS Victim Support & Advocacy	Received vm from V. F. urned her call, no answer, left vm.	Alice Hayes	Show/Edit
Susan Wilson	04/12/2022	CJS Victim Notification	TC to V to introduce self - no answer, left vm asking Susan Wilson to return my call	Alice Hayes	Show/Edit

[Back to Case](#) | [VSSR Quick Guide](#) | [VSSR Examples](#)

[victims:index](#)

Georgia[®] Department of
Community Affairs



LOANS ARE AVAILABLE TO

- First-time homebuyers
- Homebuyers who have not owned a home in the past three years
- Those who purchase a home in certain areas

ADDITIONAL QUALIFICATIONS

- Have a household income up to the maximum
- Have liquid assets of no more than \$20,000 or 20% of the sales price (whichever is greater)
- Meet mortgage loan credit requirements

DOWN PAYMENT ASSISTANCE

Effective April 1, 2021, the amounts of each loan type are temporarily increased to the following limits.

- \$7,500: Standard
- \$10,000: Protectors, Educators & Nurses (PEN)
- \$10,000: CHOICE (for family members living with a disability)

Program Overview

The Georgia Dream program was created to make homeownership possible for eligible low- and moderate-income Georgians by providing affordable financing options, down payment assistance, and homebuyer education. The Georgia Department of Community Affairs (DCA) acts as the secondary market for lenders who want to provide an affordable mortgage product. Potential homebuyers apply with participating lenders for Georgia Dream loans. The loans are secured or guaranteed by FHA, VA, USDA-RD or conventional uninsured loans. Once the lender has completed the process and gives credit approval, the information is forwarded to DCA for compliance review and funding approval. Rates are available from participating lenders. Borrowers must attend and complete either a homebuyer education workshop, individual housing counseling sessions, or an online homebuyer education course through E-Home America.

Defendant	DA#	Status	Status Note	Court #	Case Type
Luke Harrison Waldrop	22CLK00559	Closed 09/21/2023	PG - 24 months probation - 40 hours comm service - defensive driving course	SU-23-CR-0477-S	Felony Traffic/Injury Pros: Tab Hunter

Next Event: 11/06/2023, Motion Hearing for Luke Harrison Waldrop

- Attributes
- Parties
- Charges
- Events
- Notes
- Victims
- Documents
- Attachments
- Discovery

Case Notes Sort By: Type / Updated

Investigator Note for Steven P. Atkinson

Dr. Atkinson is not available the week of 9/25; he has had scheduled vacation on the calendar since May of this year.

Please let the prosecutor know.

Thanks!

Brittany Roberts
Administrative Assistant III
Georgia Bureau of Investigation
Medical Examiners office

Attorney Note for Jason Hasty

meet with Felicia and Darius; need to meet with Shawn, and look at crash report; talk about SOP; look at clothes, vests, bicycle; look at the lighting, etc.; Brian Owens is statewide DUI coordinator can testify as to the FST; look at warrant for blood, why not taken;

Acts such as following too closely and failure to maintain lane can be considered for reckless driving. See Lesh v. State, 259 Ga. App. 325 (2003) and Shadix V. State, 179 Ga. App. 644 (1986).

Consuming intoxicants prior to driving can also add to reckless driving. See Travis v. State, 314 Ga. App. 280 (2012) and Griffis v. State, 295 Ga. App. 903 (2009). Horne v. State, 286 Ga. App. 712 (2007). Dunagan v.

Add New Note

Edit |

Delete

Created: 09/05/2023 2:22pm by Felicia Fortson

Edit |

Delete

Updated: 06/09/2023 8:31am by Jason Hasty
Created: 06/08/2023 9:32am by

State, 286 Ga. App. 668 (2007), Fraser v. State, 263 Ga. App. 764 (2000), Lesh v. State, 259 Ga. App. 325 (2003), Moore v. State 234 Ga. App. 332 (1998).

Jason Hasty

Case Summary for Luke Harrison Waldrop

On or about March 3, 2022, police responded to Tallassee Road in reference to a collision between a bicyclist and a vehicle. At the scene, Officer Denmark noted the defendant displayed physical manifestations of alcohol impairment. This included bloodshot watery eyes, thick slurred speech, and swaying back and forth. The defendant said he was driving from downtown Athens to his home off Vaughn Road. He stated he had three beers. The bicyclist was transported to the hospital where he was pronounced dead.

The victim was pedaling his bicycle along the right side of the westbound travel lane of Tallassee Road approaching the intersection of Westchester Drive. The defendant was driving his white Honda Accord also in the westbound travel lane on Tallassee Road. The defendant approached the bicyclists from the rear and did not provide enough space to safely go around the bicycle. The defendant then struck the rear of the bicyclist with his front passenger corner. The bicycle had a working headlight and a flashing red LED light facing the rear. The bicyclist was wearing a bright yellow shirt and a helmet. The collision caused the bicyclist to leave the roadway where he came to an uncontrolled final rest in a ditch.

The defendant consented to a field sobriety test. For the horizontal gaze nystagmus, Officer Denmark noted 6/6 clues were observed, with 4/6 being a good indicator of impairment. For the walk and turn test, the officer observed 5/8 of the clues, with 2/8 being a good indicator of impairment. For the one-leg stand, the officer observed 3/4 clues, with 2/4 being a good indicator of impairment. Because of these tests and the physical manifestations, he was arrested. He declined a request for a blood test and refused a blood test even after a blood search warrant was signed by Judge Wegel.

Sentence Note

PG – 24 months probation – 40 hours comm service – defensive driving course

Criminal History for Luke Harrison Waldrop

No prior arrests or convictions.

Law Enforcement Note

Edit | Delete

Created: 03/15/2022 9:58am by Kyle Thompson

Edit | Delete

Created: 09/24/2023 5:21pm by Lynn Bradberry

Edit | Delete

Created: 03/15/2022 9:33am by Kyle Thompson

Cody Behrns will be out of the office/busy with training out of state from June 1st, 2023 through June 30th, 2023.

He will also be out of state/busy from August 1st, 2023 through August 15th, 2023.

Law Enforcement Note

Pedro Cortez unavailable for court for June 15th to 24th, July 11th to 13th, and July 17th to 21st, 2023.

Law Enforcement Note

Michael Wood UNAVAILABLE June 26 to July 28, 2023

Law Enforcement Note

Joey Lewis UNAVAILABLE June 21 to 23 & July 9 to 16, 2023

Law Enforcement Note

Joey Lewis UNAVAILABLE May 8 thru 12, 2023

<p>Edit Delete</p>	<p>Updated: 09/21/2023 8:45am by Simona Arroyo Created: 05/01/2023 8:58am by Osmayra Chipana</p>
<p>Edit Delete</p>	<p>Updated: 09/21/2023 8:45am by Simona Arroyo Created: 05/02/2023 8:25am by Alice Hayes</p>
<p>Edit Delete</p>	<p>Updated: 09/21/2023 8:45am by Simona Arroyo Created: 05/18/2023 9:30am by Alice Hayes</p>
<p>Edit Delete</p>	<p>Updated: 09/21/2023 8:45am by Simona Arroyo Created: 05/31/2023 2:57pm by Alice Hayes</p>

Investigator Note for James Vivean Jones

Medical release sent to Piedmont Athens and added to LF. DB

SENT FAX REPORT

Subject: Success: Medical Release Authorization Form (Fax sent to 7064756961)

Sender: Darius Binion

Sender email: darius.binion@accgov.com

Status: Sent

Date / Time: 7 / 13 / 2022 2:53:18 PM

Speed: 14400 bps

Connection time: 01:26

Pages: 2

Total pages: 2

Resolution: Fine

Remote ID: Piedmont Healthcare

Line number: 0

Retries: 0

Description: Fax sent successfully : Success

Updated: 05/31/2023 2:58pm by Alice Hayes
Created: 04/17/2023 11:04am by Alice Hayes

Edit | Delete

Updated: 07/13/2022 3:02pm by Darius Binion
Created: 07/13/2022 3:02pm by Darius Binion

Edit | Delete

Created: 07/13/2022 2:25pm by Darius Binion

Edit | Delete

Created: 05/18/2022 9:46am by Diane L Lambeth

Investigator Note for Luke Harrison Waldrop

Added Crime Lab reports to lf. DB

Clerical Note for Luke Harrison Waldrop

05-17-2022—Indictment filed, updated CCH, copy to Alice

Attorney Note for Luke Harrison Waldrop

Reviewed Indictment.

Edit |

Delete

Created: 05/12/2022 3:48pm by Zaine Thistle

Clerical Note for Luke Harrison Waldrop

05-10-2022—Warrants received from Mag Court

Edit |

Delete

Created: 05/11/2022 2:48pm by Diane L Lambeth

Investigator Note for Luke Harrison Waldrop

4/8/22-Ofc. Denmark came by the office and let me copy his case file as well as some surveillance videos from the liquor store on Tallasse Rd where you see the bicycle pass as well as the defendant's car, the accident is not captured by the video. I have added these to laserfiche. Ofc. Denmark let me know he had another supplemental he was working on about obtaining the video, and he would let me know when that was done and I will add when it is. BG

Edit |

Delete

Created: 04/08/2022 9:13am by Ben Griggs

Investigator Note for Luke Harrison Waldrop

4/5/22-Added EMS report to laserfiche. BG

Edit |

Delete

Created: 04/05/2022 3:37pm by Ben Griggs

Investigator Note for Luke Harrison Waldrop

4/5/22-Added axon and LERMS media to laserfiche along with 911/CAD. Emailed Ofc. Denmark and asked if there were any more reports that would be added to LERMS and will update the reports if he lets me know there are. Emailed National EMS and requested the EMS report and will add when received. Emailed coroner Sonny Wilson and asked for next of kin information for victim advocate. Sgt. Wood, Ofc. Denmark, and Ofc. Lewis do not have any axon videos for this case as they were called in off duty to work the case. BG

Edit |

Delete

Updated: 04/05/2022 9:19am by Ben Griggs

Clerical Note for Luke Harrison Waldrop

03/09/22 File to Alice

Email for Shawn Denmark

From: Shawn Denmark <Shawn.Denmark@accgov.com>
Sent: Thursday, September 1, 2022 10:13 AM
To: Tyler Normandia <Tyler.Normandia@accgov.com>
Subject: Re: Luke Waldrop

We do have one and you are more than welcome to come to our office and check it out. If your missing anything you can make copies here. I will be having surgery tomorrow and will be out of the office for several weeks. If you want to schedule coming in to look at the book you can contact Sgt. Wood.

Senior Police Officer S. Denmark #2363
Athens-Clarke County Police Dept.
Traffic Enforcement/Accident Reconstruction Unit
Office: 762-400-7364

Email

Email from Def atty checking on following items:

Photos of the decedents clothing he was wearing at the time of the crash
The phlebotomist blood draw refusal form from the hospital.

Copy of our clients drivers history

Videos from the following officers that were on scene during the investigation of the crash:

- o Kitchen
- o Choudhury
- o Teets
- o Compton
- o Ramey
- o Ellison

Victim Services Note for Susan Wilson

From: Susan Wilson <susan.wilson1998@gmail.com>
Sent: Tuesday, September 27, 2022 8:34 PM
To: Alice Hayes <Alice.Hayes@accgov.com>
Subject: [EXT]Checking in

Created: 04/05/2022 9:18am by Ben Griggs

Edit | Delete

Created: 03/09/2022 3:18pm by Rosario Huisa

Edit | Delete

Created: 09/06/2022 10:03am by Tyler Normandia

Edit | Delete

Created: 08/31/2022 2:55pm by Tyler Normandia

Edit | Delete

EXTERNAL SENDER: This email originated from outside of the organization.

Do not click links or open attachments unless you recognize the sender and know the content is safe. Hello. I got your message and I thought I had responded, but I didn't hear back from you. I have a few moments before the library closes so I wanted to check in with you.

If I didn't tell you before, I did lose my chance to buy the house; I don't know all the details, but the upshot is, the person who lives next door made an offer on the house that my landlady accepted, before I could get my offer put together. This Friday is my last day in that house. As you might guess, packing up and working out where to live has consumed all the attention I have outside of work, so I haven't thought to check in before now. I do have a place to stay for a few months — some long-time friends are letting me stay with them, in one of their daughters' rooms (they have been grown and gone for several years, so there is space). After a bit of settling and adjusting, I plan to start looking for a place of my own, and a friend who works for Coldwell Banker has offered to help.

I hope you have been doing well, and that your last communication was not to send me important news, like trial dates or charge dismissals. Please send me an email to let me know that you got this, and if there is anything you think I should know about the case, or anything else.

I really appreciate all your help over the last few months and hope things progress as we would like. I hope to talk to you soon.

Thanks again,

Susan

From: Alice Hayes
Sent: Wednesday, September 28, 2022 8:30 AM
To: 'Susan Wilson' <susan.wilson1998@gmail.com>
Subject: RE: [EXT]Checking in

Created: 09/28/2022 8:30am by
Alice Hayes

Good morning, Ms. Wilson,

Thank you for reaching out. My last communication was to check in and see how you are doing, so please don't worry about having missed any updates. I didn't get a response from you, but I understood that it has been a very busy time for you.

I am so sorry to hear about the house I know that this is not the outcome you had hoped for. Is there anything you need at the moment, or anything I can do to help you?

I don't have any updates for you about the case at this time, but you are always welcome to call/email to check. I'd be happy to chat with you whenever is convenient for you. Could you let me know when you'll be available for a phone call?

Please let me know if there is anything I can assist you with,

Alice Hayes
Victim Advocate
[she/her/hers]

Office of the District Attorney

Western Judicial Circuit
325 E. Washington St. Rm 370
Athens, GA 30601
Phone - (706) 613-3240 Ext. 6835
Fax - (706) 613-3247

Victim Services Note for Susan Wilson

Meeting with Susan Wilson, 8/10/22

Mortgage approved but nothing settled.

House built in the early 70s; construction & materials "not the best". House sits on stilts & ground has settled; shifting foundation.

Appraised during middle of process to settle house/foundation.

V will be meeting with a friend in real estate, this weekend or next week.

Needs/would like suggestions for places to live as plan b. No preference as to rent/buy; whatever's available. Must be pet-friendly, V has 2 ferrets & a box turtle.

House preferred to apartment/townhome.

Jim's sister received settlement with Waldrop's insurance - she will share some with Susan, but not in one lump sum.

-> Never got confirmation from Jim's HR whether he had a pension; would like confirmation.

-> Jim worked for Allied Universal

V still needs to get with probate lawyer to find out status of estate & get motorcycle and car in her name. Couldn't find motorcycle title, only had bill of sale.

VICTIM IMPACT STATEMENT ASSISTANCE:

V lost 2 weeks from library job @ beginning

Teaching is her safe place & didn't have enough staff for her to step away.

V will touch base with library about dates she missed.

Estate attorney has Jim's tax returns; V doesn't know his exact income at this time.

Immediate financial impact.

Q8- concerned about down the road.

Q9- marital laws; didn't get access to Jim's social security

RESTITUTION ASSISTANCE:

Physical items lost in accident belonged to Jim (bike, bike accessories, bike clothing, personal belongings). David Crowe has worked up a \$ amount for bicycle (he & Kenny Kalivoda worked on insurance settlement claim).

Counseling - send V resources via email. Not faith-based.

Victim Services Note for Susan Wilson

From: Alice Hayes

Sent: Friday, August 12, 2022 5:06 PM

To: 'susan.wilson1998@gmail.com' <susan.wilson1998@gmail.com>

Edit |

Delete

Created: 08/29/2022 11:22am by Alice Hayes

Edit |

Delete

Subject: Counseling services

Dear Ms. Wilson,

Thank you for meeting with me this week. As we discussed, below is a list of some providers in the Athens area who offer counseling services. This list is not exhaustive there are other providers in the area who may be able to assist you. At your convenience and whenever you are ready, you might start by getting in touch with these providers. If you do wish to pursue counseling, I would be more than happy to help you find a provider who is a good fit for you.

Family Counseling Service of Athens
1435 Oglethorpe Ave.
Athens, GA 30606
Phone: (706) 549-7755
Web: <http://www.fcsathens.com>
Email: contactus@fcsathens.com

Person-Centered Therapy Associates
1060 Gaines School Rd.
Suite A-3
Athens, GA 30605
Phone: (706) 549-5522
Web: <http://www.personcentered.com>
Email: mail@personcentered.com

University of Georgia – Center for Counseling and Personal Evaluation
424 Aderhold Hall
4th Fl.
Athens, GA 30602
Phone: (706) 542-8508

Advantage Behavioral Health Systems
240 Mitchell Bridge Road
Athens, GA 30606-2043
Phone: (855) 333-9544
Phone: (706) 389-6767
Web: <http://www.advantagebhs.org>

Bethel Haven
1622 Mars Hills Rd.
Suite A
Watkinsville, GA 30677
Phone: (706) 310-9046
Phone: (706) 316-9076
Web: bethelhaven.net
Email: jjones@bethelhaven.net

Please let me know if you have any questions, or if there is anything else I can assist you with,

Alice Hayes

Created: 08/12/2022 5:06pm by
Alice Hayes

Victim Advocate
[she/her/hers]

Office of the District Attorney
Western Judicial Circuit
325 E. Washington St. Rm 370
Athens, GA 30601
Phone - (706) 613-3240 Ext. 6835
Fax - (706) 613-3247

Victim Services Note for Susan Wilson

TC to V to "check in". V is working on getting a mortgage to buy the property. Is considering DREAM Program & NACA (Neighborhood Assistance Corporation of America); concern is these programs may take more time than V has. V is also working on clearing out the house in case she's not able to buy & has to move.
V requested appointment to go over Victim Impact Statement. Scheduled appointment for 8/10/22 @ 9:30 am.

Victim Services Note for Susan Wilson

Rec'd 2 emails from V today:
On Fri, Jul 15, 2022 at 1:56 PM Susan Wilson <susan.wilson1998@gmail.com> wrote:
Dear Alice,

Thanks for the copy of the paperwork. I'll work on it tonight. I really need to do that now, as the owner of the house where I live has decided to sell it. I have until September 30 to move out or buy it. Needless to say, I am completely floored.

From: Susan Wilson <susan.wilson1998@gmail.com>
Sent: Friday, July 15, 2022 4:02 PM
To: Alice Hayes <Alice.Hayes@accgov.com>
Subject: [EXT] Re: Victim Impact Statement

What was the name of the program you mentioned in our conversation yesterday? Not the Homebuyer Education workshop (don't know if I could get in on one soon enough to do me any good), but the other one (Georgia Dream, I think?)?

Thanks for all your help,
Susan

Did not directly respond to either email, because I was already working on email to V. Instead, called V & let her know to expect email from me with potential resources. Discussed landlady situation. V confirmed that landlady is definitely selling the house & advised V she will be receiving notice to vacate shortly.

Edit | Delete

Created: 08/04/2022 4:44pm by
Alice Hayes

Edit | Delete

Created: 07/15/2022 4:32pm by
Alice Hayes

Sent the following email to V (flyer referenced in email is in Tracker attachments) -

From: Alice Hayes
Sent: Friday, July 15, 2022 4:28 PM
To: 'susan.wilson1998@gmail.com' <susan.wilson1998@gmail.com>
Subject: Resources

Ms. Wilson,

Further to our conversation yesterday, here are some additional resources which may be of assistance to you. Again- these are just a jumping-off point. If these resources are not a good fit, please let me know, and I will keep looking.

Georgia Dream Homeownership Program
This program offers funding for eligible low- and moderate-income first-time buyers to assist with down payment and closing costs. The program also provides affordable financing options and homebuyer education. Home purchase price (for Athens-Clarke County) cannot exceed \$275,000; household income, for a household of 1 or 2 people, cannot exceed \$72,000. As an educator, you may be eligible for up to \$10,000 in down payment assistance.
The Program website has further information, including frequently asked questions; a list of participating lenders; home buyer education resources; and more. I have also attached the Program flyer.

Athens Land Trust
In addition to the homebuyer education classes we discussed yesterday, Athens Land Trust provides affordable housing for purchase or rent. They host online informational sessions, free of charge, on the second Tuesday of the month at 12:00pm and every 4th Wednesday of the month at 5:30pm.
For further information and to register for information sessions: <https://athenslandtrust.org/our-work/affordable-housing/affordable-housing-info-sessions/>
Athens Land Trust affordable rental options: <https://athenslandtrust.org/our-work/affordable-housing/rental-options/>

Budget assistance/budget counseling
The following organizations offer budget counseling/assistance:
The Ark | <https://www.athensark.org/home> | 706-548-8155
The Aspire Clinic at UGA | <https://www.fcs.uga.edu/aspireclinic> | 706-542-4486
(NOTE: Currently closed for financial planning assistance. Their wait list opens up August 1. The Aspire Clinic also offers legal problem-solving.)

Please let me know if there is anything else I can assist you with,

Alice Hayes
Victim Advocate
[she/her/hers]

Office of the District Attorney
Western Judicial Circuit
325 E. Washington St. Rm 370
Athens, GA 30601
Phone - (706) 613-3240 Ext. 6835
Fax - (706) 613-3247

Victim Services Note for Susan Wilson

07.14.22: TC to V Susan Wilson; discussed resources/financial needs.

- *V isn't sure yet exactly what sort of financial assistance resources are needed
- *Is working on reducing her utility bills (cutting non-essential services). Is on well water, water bill isn't a concern. Power bill has decreased since James passed away- less power usage due to fewer people in home.
- *BIGGEST CONCERN: Landlady is talking about selling the house V rents. V doesn't know if landlady will consider selling to her, or for what price. Landlady has had two real estate agents come out to do an appraisal.
- *V hasn't started looking for an alternative place to live yet; needs to sit down & crunch numbers to figure out what she can afford. V is a teacher, currently very busy prepping for new school year.
- *V is afraid to do/say anything that might make landlady feel pressured to make a decision/sell.
- *V also needs help with her "weird financial situation"- stated she has money from James' life insurance and money from car insurance settlement. [Wrongful death suit was mentioned; not clear if this has settled or if V anticipates getting money from that in future.] V is not sure how that factors into taxes- is it counted as income? Is it taxed as income? When applying for financial resources, is that money taken into account?
- *Has changed some utilities to lower-cost options; will be getting landline & TV cut off.

Asked V questions to determine if she may qualify for Georgia Dream Homeownership Program. Confirmed that this would be V's first time purchasing a home (Dream is only for first-time buyers). V stated that her income "fluctuates a good bit" but it is less than \$72,000/year (income limit for Dream program for household of 1 or 2 persons). V is an educator, so may qualify for \$10,000 down payment assistance through Dream.

REFERRED V to Athens Land Trust for homebuyer education classes; budget & credit counseling; rental counseling; pre-purchase counseling; and possible assistance with utilities. Discussed Georgia Dream Homeownership Program with V; suggested she discuss this with Athens Land Trust, as they will be more knowledgeable about the program than I am. Will be emailing V additional resources/referrals.

Victim Services Note for Susan Wilson

Sent the following email to V (link referenced in email was embedded in text & tested before sending) -

From: Alice Hayes
 Sent: Thursday, July 14, 2022 5:38 PM
 To: 'susan.wilson1998@gmail.com' <susan.wilson1998@gmail.com>
 Subject: Victim Impact Statement

Ms. Wilson,

Thank you for speaking with me earlier. As requested, attached is a copy of the Victim Impact Statement and other paperwork which we previously mailed.

I will be following up with you via email tomorrow with resources we discussed. In the meantime, here is the link to Athens Land Trust's Homebuyer Education Classes. The next classes are July 23 and August 20, from 8:30am-4:30pm since this conflicts with your work schedule, it may be worth calling Athens Land Trust

Edit |

Delete

Updated: 07/15/2022 9:26am by Alice Hayes

Created: 07/15/2022 9:25am by Alice Hayes

Edit |

Delete

Updated: 07/14/2022 5:40pm by Alice Hayes

Created: 07/14/2022 5:39pm by Alice Hayes

and/or emailing Ayanna Hall, Housing Counselor (ayanna@athenslandtrust.org) to discuss further.

Thank you again for speaking with me, and please let me know if I can be of any further assistance,

Alice Hayes
Victim Advocate
[she/her/hers]

Office of the District Attorney
Western Judicial Circuit
325 E. Washington St. Rm 370
Athens, GA 30601
Phone – (706) 613-3240 Ext. 6835
Fax – (706) 613-3247

Victim Services Note for Susan Wilson

Ms. Wilson would like to discuss financial assistance resources in the area. Due to conflicting schedules, we have not had the opportunity to discuss (Ms. Wilson has been busy when I've been available, and vice versa). Sent the following email today:

From: Alice Hayes
Sent: Wednesday, July 6, 2022 3:30 PM
To: 'susan.wilson1998@gmail.com' <susan.wilson1998@gmail.com>
Subject: Financial assistance resources

Ms. Wilson,

I hope you are doing well, and had a wonderful holiday weekend. I am sorry I have not yet had the opportunity to speak with you about financial assistance resources. I am in trial this week, but will give you a call as soon as I can. In the meantime, listed below are some community resources I am aware of. Take a look through this list and let me know if any of these resources suit your needs if they do not, I would be happy to keep looking.

This list is just a jumping-off point- it is not exhaustive. If you would like any further information about these resources/agencies, just let me know.

RENT/MORTGAGE PAYMENT ASSISTANCE:

- ACTION, Inc.
- (706) 850-8199 | www.actionathens.org
- Ark United Ministry Outreach Center
- (706) 548-8155 | www.athensark.org
- Athens Land Trust
- (706) 613-0122 | www.athenslandtrust.org | admin@athenslandtrust.org
- St. Joseph Charities
- (706) 850-7777 | sjcathens@gmail.com
- The Salvation Army Athens
- (706) 543-5350 | https://southernusa.salvationarmy.org/athens

NUTRITION/FOOD ASSISTANCE:

Edit | Delete

Created: 07/06/2022 3:34pm by
Alice Hayes

- Athens Area Emergency Food Bank*
 *NOTE: Referral is required. If you feel you could benefit from the Athens Area Emergency Food Bank, please let me know.
 (706) 353-8182 | www.athensfoodbank.org | aaeafb@bellsouth.net
 - Cornerstone Church Food Pantry
 (706) 549-0000 | www.cornerstoneathens.cc | info@cornerstoneathens.cc
 - Covenant Presbyterian Church of Athens Food Pantry
 (706) 548-2756 | www.covpresathens.org | kwetherington@covpresathens.org
 - East Athens Development Corporation, Inc.
 (706) 208-0048 | www.eadcinc.org | eastathensdc@gmail.com

UTILITIES ASSISTANCE:

- ACTION, Inc.
 (706) 850-8199 | www.actionathens.org
 - Ark United Ministry Outreach Center
 (706) 548-8155 | www.athensark.org
 - Athens Land Trust
 (706) 613-0122 | www.athenslandtrust.org | admin@athenslandtrust.org
 - St. Joseph Charities
 (706) 850-7777 | sjcathens@gmail.com
 - The Salvation Army Athens
 (706) 543-5350 | https://southernusa.salvationarmy.org/athens

Thank you, and please let me know if there is anything else I can assist you with,

Alice Hayes
 Victim Advocate
 [she/her/hers]

Office of the District Attorney
 Western Judicial Circuit
 325 E. Washington St. Rm 370
 Athens, GA 30601
 Phone - (706) 613-3240 Ext. 6835
 Fax - (706) 613-3247

Victim Services Note for Susan Wilson

Rec'd & responded to email from V. My email bounced back undeliverable. We are having internet issues today so this is a problem on 'our' end. Will re-send email as soon as possible.
 UPDATE: Email went through, 6/28/22 3:29pm

From: Susan Wilson <susan.wilson1998@gmail.com>
 Sent: Friday, June 24, 2022 5:27 PM
 To: Alice Hayes <Alice.Hayes@accgov.com>
 Subject: [EXT] Re: State v. Luke Waldrop: Arraignment, 6/22/22, 9:00am

Good afternoon Ms. Hayes,

Edit | Delete

Updated: 06/28/2022 3:29pm by Alice Hayes
 Created: 06/27/2022 5:47pm by Alice Hayes

I am not entirely sure I want to know the answer to this question, but I'll go ahead and ask anyway. Have you learned any more about the plea Luke Waldrop entered on Tuesday — i.e., was there a plea agreement made, and if so, what did it involve? I would appreciate anything you can tell me about this and the next steps; there are other folks in town (friends of Jim's) who are interested as well, so I would like to be able to tell them something.

Thank you for all your help,

Susan

From: Alice Hayes
Sent: Monday, June 27, 2022 5:44 PM
To: 'Susan Wilson' <susan.wilson1998@gmail.com>
Subject: RE: [EXT] Re: State v. Luke Waldrop: Arraignment, 6/22/22, 9:00am

Ms. Wilson,

I hope I can put your mind at ease. No plea agreement has been made. Plea agreements are a negotiation process, and we always start by speaking with the victims if the Assistant District Attorney has a plea recommendation in mind, we will give you a call to explain the recommendation and get your thoughts before we speak with the defense. We always seek victims input before making an offer.

The case is still in its early stages at this time. Currently, there are no further hearings scheduled, but as soon as something is scheduled, we will reach out to let you know. At some point in future, the case will be put on a Trial Calendar, which is a numbered list of cases scheduled for trial during a particular week. When the case will be scheduled for trial, and where on that list it will be, is determined by the judges office; so unfortunately I do not know when this will be. Typically, a trial week starts on a Monday. A Plea Calendar (sometimes called a Status Conference) is held the Friday before trial at this time, the judge will go through the Trial Calendar to confirm which cases are ready for trial; whether a plea offer has been made; and whether any plea has been accepted/rejected.

The above is a general outline, but every case is different. We will notify you of any hearings scheduled in the case. Of course, you are always welcome to call to check if anything is scheduled.

Further to our conversation last week, I did confirm that Mr. Waldrop is currently out on bond. It looks like he was granted a bond before his case came to our office.

Is there a good day/time this week when I could call you to discuss community resources and financial assistance?

Thank you,

Alice Hayes
Victim Advocate
[she/her/hers]

Office of the District Attorney
Western Judicial Circuit
325 E. Washington St. Rm 370
Athens, GA 30601

Phone - (706) 613-3240 Ext. 6835
Fax - (706) 613-3247

Victim Services Note for Susan Wilson

TC to V - notified of Arraignment. V said she is still working on the initial contact paperwork including VIS, stated it is very hard to fill it all out - I told her to take her time, we certainly understand. Discussed arraignment and logistics of where to go and when, etc. Also advised that one of the services we provide is referral to community resources, and I would be happy to discuss this- V thanked me & said she will probably be calling back about that.

Advised V I would also send summary of our conversation via email. Emailed V but it came back undeliverable. Called V again & confirmed/updated email address.

From: Alice Hayes
Sent: Tuesday, June 14, 2022 5:39 PM
To: 'susan.wilson1998@gmail.com' <susan.wilson1998@gmail.com>
Subject: State v. Luke Waldrop: Arraignment, 6/22/22, 9:00am

Good afternoon, Ms. Wilson,

I hope that you are doing well. This is a courtesy notice to let you know that Luke Waldrop's case is scheduled for Arraignment on June 22 at 9:00 a.m. As a victim in the case, you have the right to attend this hearing if you would like to. (You are not required to attend.)

If you would like to attend the hearing, we recommend that you park in the courthouse parking deck and bring your parking ticket in with you so we can validate it for you. The courthouse is located at the 325 E. Washington Street address below. I would also recommend that you arrive a little before the hearing, and come to our office in Room 370 of the courthouse, so that I can meet you there.

Please let me know if you have any questions, or if there is anything else I can assist you with. One of the services we offer is referral to community resources and other sources of assistance - I would be more than happy to discuss this with you further.

Thank you,

Alice Hayes
Victim Advocate
[she/her/hers]

Office of the District Attorney
Western Judicial Circuit
325 E. Washington St. Rm 370
Athens, GA 30601
Phone - (706) 613-3240 Ext. 6835
Fax - (706) 613-3247

Victim Services Note for Melody Ann Jones

Edit |

Delete

Created: 06/14/2022 5:39pm by
Alice Hayes

Rec'd vm from Melody Jones, stating she has a question about the Victim Impact Statement. Returned her call, no answer. Left vm asking V to return my call to discuss VIS.

Victim Services Note for Melody Ann Jones

Called Melody Jones – introduced self & office, told Ms. Jones I am so sorry for her loss. Advised that I am here to help & support her through this case; advised I will be mailing information & confirmed contact info. V stated that she can be reached by email if that's easier for our office – I asked V if she has a preference as to email/ phone/ mail contact; V has no preference, stated, "whatever is easiest for you". V thanked me for calling, had no questions/ concerns at this time. Advised V to please call if she has any qs/ concerns, I'd be happy to help.

Victim Services Note for Susan Wilson

4-20-2022—Alice asked me to reach out to the family member about CVC. I called Ms. Wilson and she told me that V's sister paid for the funeral bill. She will send me her contact information for an application.

Victim Services Note for Susan Wilson

V returned my call. I introduced myself, confirmed Ms. Wilson's relationship to James Jones – they were partners for 37 years – & told Ms. Wilson I am sorry for her loss. Advised that I am here to help & support her through this case; advised I will be mailing information & confirmed contact info. Email is the best way to reach V. Texts okay also.
>During our call, V said that she might have to have her landline cut off because she "doesn't have the money"; later V stated that email is the best way to reach her because "even if her internet is cut off" she'll still be able to access it. V may need financial assistance/resources.

Asked V if she had any questions/ concerns for me at this time.
V wanted to know if D is incarcerated – V stated she has not been able to obtain much info from Sgt. Wood, but last she heard. D had bonded out but PD were looking for him. I verified that D bonded out & is not incarcerated at this time.

V asked if I had an idea of when this case might go to a hearing – I advised I do not, and that nothing is scheduled at the moment; I also checked clerk's website just in case, & don't see anything scheduled yet. Advised that as soon as something is scheduled I will let V know.

V also asked about the charges – confirmed the charges, at this time, are Homicide by Vehicle 1st Degree; DUI; Improper Passing of Bicycle.

V stated that James Jones has a living relative – his sister, Melody Jones. Ms. Wilson did not have contact

Edit | Delete

Created: 05/23/2022 10:20am by
Alice Hayes

Edit | Delete

Created: 04/20/2022 4:54pm by
Alice Hayes

Edit | Delete

Created: 04/20/2022 4:06pm by
Fatma Gurel

Edit | Delete

Created: 04/15/2022 4:57pm by
Alice Hayes

info for her when we spoke but said if I email her she will respond with contact info when she is able to look it up.

V had no further questions/concerns at this time, said she probably will when she receives paperwork; I advised that is fine, & please reach out any time.
V thanked me for calling.

CCH Note for Luke Harrison Waldrop

Imported from CCH on 03/09/2022 by Rosario Huisa...

Created: 03/09/2022 1:55pm by
Rosario Huisa

Back to Case
notes:index

Defendant	DA#	Status	Status Note	Court #	Case Type
Luke Harrison Waldrop	22CLK00559	Closed 09/21/2023	PG - 24 months probation - 40 hours comm service - defensive driving course	SU-23-CR-0477-S	Felony Traffic/Injury Pros: Tab Hunter

Next Event: 11/06/2023, Motion Hearing for Luke Harrison Waldrop

- Attributes
- Parties
- Charges
- Events
- Notes
- Victims
- Documents
- Attachments
- Discovery

Victim Stats							(Show Witnesses)
Role	Notify	Victim	County	Dem	VSSR	VAWA	Disp.
Victim- Deceased	Y	James Vivean Jones	(Deceased)				
Family Member of Victim	Y	Melody Ann Jones	Out of State	//?	Survivors of Homicide		Pled to Lesser/Lower Category Edit Del
Family Member of Victim	Y	Susan Wilson	Clarke	//?	Survivors of Homicide		Pled to Lesser/Lower Category Edit Del

Set Notifications | Set Restitution | Set Dispositions

Victim Services				Add Service Add Information/Referral
Victim/Witness	Date	Service	Note	Staff
Susan Wilson	09/25/2023	4 services	Susan called in with more questions for the plea that was accepted on her case. Provided answers that I could. Advised that I would call back with other answers when I get them.	Simona Arroyo Show/Edit
Susan Wilson	09/21/2023	4 services	Called to give result of plea. Offered additional support if needed.	Simona Arroyo Show/Edit
Melody Ann Jones	09/21/2023	4 services	Called to let her know plea reresults. She is not happy, but understands the legal process has been done.	Simona Arroyo Show/Edit

Susan Wilson	09/21/2023	4 services	TTC partner to give details of plea offer and to notify of upcoming trial LVM	Simona Arroyo	Show/Edit
Melody Ann Jones	09/21/2023	4 services	Called sister to give details of the plea offer and to give information of the upcoming trial. She is totally against the plea offer as it stands and wants the D to have to serve time	Simona Arroyo	Show/Edit
Susan Wilson	09/30/2022	Individual Support	TTC V as she requested - no answer, left vm & texted, per V request	Alice Hayes	Show/Edit
Susan Wilson	09/28/2022	2 services	Rec'd & responded to email from V - see notes	Alice Hayes	Show/Edit
Susan Wilson	08/30/2022	Individual Support	Called V to "check in" - no answer, left vm stating I was calling to check in & see how everything is going, & could V please return my call @ her convenience	Alice Hayes	Show/Edit
Susan Wilson	08/12/2022	2 services	Emailed V list of counseling resources - see notes	Alice Hayes	Show/Edit
Susan Wilson	08/10/2022	4 services	Meeting w/ V (1hr 10mins) to advise on VIS and restitution form; discuss needs/resources (see notes)	Alice Hayes	Show/Edit
Susan Wilson	08/04/2022	Individual Support	Called V to "check in" - see notes. Scheduled appointment w/ V for 8/10/22 @ 9:30	Alice Hayes	Show/Edit
Susan Wilson	07/15/2022	2 services	Rec'd 2 emails from V- see notes; did not respond to emails, called her instead. Sent separate email with possible resources; see notes.	Alice Hayes	Show/Edit
Susan Wilson	07/14/2022	5 services	Emailed copy of initial contact/intake paperwork, per V request	Alice Hayes	Show/Edit
Susan Wilson	07/14/2022	2 services	TC to V, discussed financial needs & possible resources - see notes. Emailed link/referral to Athens Land Trust Homebuyer Education Classes.	Alice Hayes	Show/Edit
Susan Wilson	07/14/2022	Individual Support	TC to V, discussed financial needs & possible resources - see notes. Emailed link/referral to Athens Land Trust Homebuyer Education Classes.	Alice Hayes	Show/Edit
Susan Wilson	07/06/2022	2 services	Emailed V list of financial assistance resources - see notes	Alice Hayes	Show/Edit
Melody Ann Jones	07/06/2022	Individual Support	Sent Piedmont Athens Regional release form to Melody Jones for signature	Alice Hayes	Show/Edit
Susan Wilson	06/30/2022	Individual Support	Called to discuss V's financial needs - V asked if I could call her back Tuesday morning. Advised I will be in trial but Tuesday morning could work- depends on how long jury selection lasts. Will f/u with V.	Alice Hayes	Show/Edit
Melody Ann Jones	06/30/2022	CJS Victim Support & Advocacy	Called to ask Ms. Jones if she could please sign medical release so we can obtain V's records - no answer, left vm asking her to call me back	Alice Hayes	Show/Edit
Susan Wilson	06/27/2022	2 services	Called V - she was teaching class & couldn't talk. Let her know I got her email & responded but we're having server issues; I will re-send ASAP.	Alice Hayes	Show/Edit

Susan Wilson	06/27/2022	5 services	Responded to email from V - email immediately bounced back, we are having internet issues today. Will re-send ASAP.	Alice Hayes	Show/Edit
Melody Ann Jones	06/24/2022	4 services	Notified of Arraignment outcome	Alice Hayes	Show/Edit
Susan Wilson	06/22/2022	4 services	Notified of Arraignment outcome (in person- Ms. Wilson attended Arraignment)	Alice Hayes	Show/Edit
Melody Ann Jones	06/22/2022	CJS Victim Support & Advocacy	Attended court	Alice Hayes	Show/Edit
Susan Wilson	06/22/2022	CJS Victim Support & Advocacy	Attended court with Susan Wilson	Alice Hayes	Show/Edit
Susan Wilson	06/22/2022	CJS Victim Notification	ACC phones are down/cannot receive incoming calls - texted V so she'd have a way to contact me	Alice Hayes	Show/Edit
Susan Wilson	06/21/2022	4 services	Rec'd call from V - discussed what to expect tomorrow (Arraignment)	Alice Hayes	Show/Edit
Susan Wilson	06/17/2022	2 services	V called - wanted to know if she can have a friend accompany her to arraignment for support. Advised that should be fine	Alice Hayes	Show/Edit
Melody Ann Jones	06/14/2022	4 services	Notified of Arraignment via phone (vm) & email	Alice Hayes	Show/Edit
Susan Wilson	06/14/2022	4 services	Notified of Arraignment via phone & email - see notes	Alice Hayes	Show/Edit
Melody Ann Jones	05/23/2022	CJS Victim Support & Advocacy	V returned my call - just wanted to know if she *has to* complete VIS. Would like updates on case but "doesn't need assistance".	Alice Hayes	Show/Edit
Melody Ann Jones	05/23/2022	2 services	See notes	Alice Hayes	Show/Edit
2 victims	05/17/2022	2 services	Attended court	Alice Hayes	Show/Edit
Melody Ann Jones	04/20/2022	4 services	Mailed initial contact packet	Alice Hayes	Show/Edit
Melody Ann Jones	04/20/2022	4 services	TC to V - see notes	Alice Hayes	Show/Edit
Susan Wilson	04/15/2022	2 services	Texted V to confirm email address & contact info for Melody Jones	Alice Hayes	Show/Edit
Susan Wilson	04/15/2022	2 services	Emailed V, per her request - it bounced back undeliverable. Will text instead.	Alice Hayes	Show/Edit
Susan Wilson	04/15/2022	4 services	Mailed initial contact packet	Alice Hayes	Show/Edit
Susan Wilson	04/15/2022	4 services	TC from V - see notes	Alice Hayes	Show/Edit

Susan Wilson	04/15/2022	CJS Victim Support & Advocacy	Received vm from V. Returned her call, no answer, left vm.	Alice Hayes	Show/Edit
Susan Wilson	04/12/2022	CJS Victim Notification	TC to V to introduce self - no answer, left vm asking Susan Wilson to return my call	Alice Hayes	Show/Edit

[Back to Case](#) | [VSSR Quick Guide](#) | [VSSR Examples](#)

[victims:index](#)

Georgia[®] Department of
Community Affairs



LOANS ARE AVAILABLE TO

- First-time homebuyers
- Homebuyers who have not owned a home in the past three years
- Those who purchase a home in certain areas

ADDITIONAL QUALIFICATIONS

- Have a household income up to the maximum
- Have liquid assets of no more than \$20,000 or 20% of the sales price (whichever is greater)
- Meet mortgage loan credit requirements

DOWN PAYMENT ASSISTANCE

Effective April 1, 2021, the amounts of each loan type are temporarily increased to the following limits.

- \$7,500: Standard
- \$10,000: Protectors, Educators & Nurses (PEN)
- \$10,000: CHOICE (for family members living with a disability)

Program Overview

The Georgia Dream program was created to make homeownership possible for eligible low- and moderate-income Georgians by providing affordable financing options, down payment assistance, and homebuyer education. The Georgia Department of Community Affairs (DCA) acts as the secondary market for lenders who want to provide an affordable mortgage product. Potential homebuyers apply with participating lenders for Georgia Dream loans. The loans are secured or guaranteed by FHA, VA, USDA-RD or conventional uninsured loans. Once the lender has completed the process and gives credit approval, the information is forwarded to DCA for compliance review and funding approval. Rates are available from participating lenders. Borrowers must attend and complete either a homebuyer education workshop, individual housing counseling sessions, or an online homebuyer education course through E-Home America.



IN THE SUPERIOR COURT OF CLARKE COUNTY
STATE OF GEORGIA

THE STATE OF GEORGIA

*
*
*
*
*
*

v.

CASE #: SU-23-CR-0477-S

LUKE HARRISON WALDROP
Defendant

2023 NOV -3
2:10
ATHLETIC CENTER
CLARKE COUNTY

**STATE'S RESPONSE TO MOTION FOR HEARING ON MARSY'S LAW VIOLATION
AND REQUEST TO DISMISS**

COMES NOW the State of Georgia, by and through the undersigned District Attorney in the above-styled case, and files this Response to the Movant's Motion for Hearing on Marsy's Law Violation. The State requests this Court dismiss the movant's position due to lack of standing to bring the action.

1.

The State presents that Movant, Susan Wilson, is the long-time partner, not the spouse, of James V. Jones, the deceased victim in the indictment against Luke Harrison Waldrop (the "Defendant"), Criminal Action File No. SU-22-CR-0321.

2.

Movant and Mr. Jones were never officially married. On April 15, 2022, the Victim Advocate on the case "confirmed Ms. Wilson's relationship to James Jones – they were *partners* for 37 years" (Tracker Notes). At no time did Movant identify herself as Mr. Jones's wife. Georgia is not a Common Law Marriage State. However, Georgia does recognize Common Law marriages if the individuals meet 4 criteria including that they had to have been holding themselves out as husband and wife prior to January 1, 1997. Movant did not to hold herself out to be Mr. Jones's wife at any time to the State.

3.

According to GA Code § 17-17-3 (2022), only victims in a case would have standing to file a Marsy's law violation. Domestic Partners are not considered victims under GA Code § 17-17-3; therefore, under GA Code § 17-17-3, the movant would lack standing to bring this action and it should be dismissed, based on the law GA Code § 17-17-3. The State moves this Court to find

as such and dismiss movant action filed under this case.

Given that fact, the Victim Advocates in the case did not consider Movant as the victim pursuant to § 17-17-3 for notification purposes.

GA Code § 17-17-3 (2022)

11. "Victim" means:

- A. A person against whom a crime has been perpetrated or has allegedly been perpetrated; or
- B. In the event of the death of the crime victim, the following relations if the relation is not either in custody for an offense or the defendant:
 - i. *The spouse*;
 - ii. An adult child if division (i) of this subparagraph does not apply;
 - iii. A parent if divisions (i) and (ii) of this subparagraph do not apply;
 - iv. *A sibling* if divisions (i) through (iii) of this subparagraph do not apply; or
 - v. A grandparent if divisions (i) through (iv) of this subparagraph do not apply; or
- C. A parent, guardian, or custodian of a crime victim who is a minor or a legally incapacitated person except if such parent, guardian, or custodian is in custody for an offense or is the defendant.

4.

Even with that definition, the Victim Advocates attempted contact with Movant at the same time they attempted contact with the deceased's sister. There are various instances listed in Tracker where the Movant was notified along with the sister. There are also notes of how the Movant was not issued the insurance benefits because she was not recognized as the wife or spouse of Mr. Jones. The next of kin, Mr. Jones's sister received those. Due to these circumstances, the State believed that it had met the responsibility of victim notification based on § 17-17-3.

5.

The State attempted to make contact with both the sister of the deceased and the Movant regarding the plea negotiation prior to the plea being finalized in Court. The sister gave feedback that she was in disagreement with the offer. The sister was asked if she would like to come to the proceeding to give a Victim Impact Statement. The sister declined. The Movant did not respond to the voice message left to her in regards to the plea and the proceeding.

6.

The State made the Court aware that the Victim (deceased's sister) was in disagreement with

the plea:

"Mr. Neal: Your Honor, we have spoken with the family of the victim (deceased) and they have been notified of any – of the offer in this case, Your Honor. And they have been notified of the problems that we were receiving with evidence Your Honor. And they are in formal disagreement with the – with the plea agreement, Your Honor, and wish for the defendant to serve jail time." (Transcript of Guilty Plea, September 21, 2023, pg. 15)

7.

The Court, now notified and with knowledge of the Victim's disagreement with the plea, and after thoughtful consideration and hearing from the Defendant's attorney, accepted the plea bargain.

"The Court: All right. Mr. Ballard, I'm going to have – you're going to have to convince me why I should take this plea bargain." (Transcript of Guilty Plea, September 21, 2023, pg. 13)

"The Court: It's a tragedy. All right. I'm going to sentence you in accordance with the plea bargain." (Transcript of Guilty Plea, September 21, 2023, pg. 17)

WHEREFORE, the State of Georgia prays this Court find movant without standing in this action and dismiss movant's action. Alternatively, the State would ask this Court to not find our Office in violation of Marsy's Law as we made victim notification regarding the plea offer to the victim as defined by the Georgia State Code, and let the Court know of the victim's disagreement with the plea before the Court made the final decision on accepting the plea recommendation and sentencing the defendant.

Respectfully submitted this 3rd day of November, 2023.

 /s/ Deborah Gonzalez

Deborah Gonzalez
District Attorney
Western Judicial Circuit
Georgia Bar Number 432657

IN THE SUPERIOR COURT OF OCONEE COUNTY
STATE OF GEORGIA

THE STATE OF GEORGIA

v.

LUKE HARRISON WALDROP
Defendant

*
*
*
*
*

CASE #: SU-23-CR-0477-S

CERTIFICATE OF SERVICE

I hereby certify that I have served a copy of the **STATE'S RESPONSE TO MOTION FOR HEARING ON MARSY'S LAW VIOLATION** on the Defendant through their attorney, Robbie Ballard, and to the Movant through their attorney, Kevin Epps, by email on the 3rd day of November, 2023 at ballard@hbbfirm.com and kevin@ehdhlaw.com respectfully.

/s/ Deborah Gonzalez

Deborah Gonzalez
District Attorney
Western Judicial Circuit
Georgia Bar Number 432657

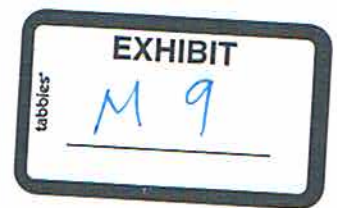

From: [Deborah Gonzalez](#)
To: [Lynn Bradberry](#)
Subject: RE: Definition of Victim (Waldrop Case)
Date: Monday, October 30, 2023 11:16:54 AM

Thank you

From: Lynn Bradberry <Lynn.Bradberry@accgov.com>
Sent: Monday, October 30, 2023 8:23 AM
To: Deborah Gonzalez <Deborah.Gonzalez@accgov.com>
Subject: RE: Definition of Victim (Waldrop Case)

Please see attached – Look at section (11)

From: Deborah Gonzalez <Deborah.Gonzalez@accgov.com>
Sent: Monday, October 30, 2023 8:10 AM
To: Lynn Bradberry <Lynn.Bradberry@accgov.com>
Cc: Deborah Gonzalez <Deborah.Gonzalez@accgov.com>
Subject: Definition of Victim (Waldrop Case)

Good morning Lynn:

Can you please send me the statute of where a victim is defined that you are relying on that Susan Wilson is not a victim?

She is listed as "spouse" in the Marsy's Law motion.

Thank you,

Deborah

--

Deborah Gonzalez
District Attorney
Western Judicial Circuit
Athens-Clarke & Oconee Counties
www.westerncircuitda.com



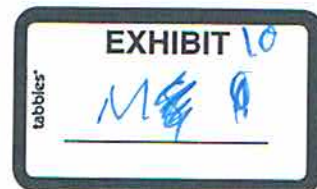

From: [Simona Arroyo](#)
To: [Deborah Gonzalez](#); [Robert Wilson](#); [Lynn Bradberry](#)
Cc: [Simona Arroyo](#)
Subject: RE: Luke Waldrop SU-23-CR-0477-S
Date: Tuesday, September 26, 2023 2:05:29 PM
Attachments: [image001.png](#)

Her confirmed email address is:

susan.wilson1998@gmail.com

You're welcome,

Simona Arroyo

Victim Advocate
District Attorney's Office
Western Judicial Circuit
325 E. Washington St.
Suite 370
Athens, GA 30601

Direct Phone: (762) 400-6814
Office Phone: (706) 613-3240 Ext. 6814
Fax: (706) 613-3247



The Unified Government of Athens-Clarke County is a public entity subject to Georgia's Open Records Act OCGA sections 50-18-70 to 50-18-76. Email messages are covered under such laws and are subject to disclosure unless specifically protected by law.

From: Deborah Gonzalez <Deborah.Gonzalez@accgov.com>
Sent: Tuesday, September 26, 2023 1:57 PM
To: Robert Wilson <Robert.Wilson@accgov.com>; Lynn Bradberry <Lynn.Bradberry@accgov.com>
Cc: Simona Arroyo <Simona.Arroyo@accgov.com>; Deborah Gonzalez <Deborah.Gonzalez@accgov.com>
Subject: Re: Luke Waldrop SU-23-CR-0477-S

Simona – can you get me her email address?

Thank you,

Deborah

From: Deborah Gonzalez <Deborah.Gonzalez@accgov.com>
Date: Tuesday, September 26, 2023 at 1:54 PM
To: Robert Wilson <Robert.Wilson@accgov.com>, Lynn Bradberry <Lynn.Bradberry@accgov.com>
Cc: Simona Arroyo <Simona.Arroyo@accgov.com>, Deborah Gonzalez <Deborah.Gonzalez@accgov.com>
Subject: Re: Luke Waldrop SU-23-CR-0477-S

Thank you Robert, Simona, and Lynn - I will put all these pieces together for a response for the victim.

Deborah

From: Robert Wilson <Robert.Wilson@accgov.com>
Date: Tuesday, September 26, 2023 at 1:52 PM
To: Deborah Gonzalez <Deborah.Gonzalez@accgov.com>, Simona Arroyo <Simona.Arroyo@accgov.com>, Lynn Bradberry <Lynn.Bradberry@accgov.com>
Cc: Simona Arroyo <Simona.Arroyo@accgov.com>, Deborah Gonzalez <Deborah.Gonzalez@accgov.com>
Subject: Re: Luke Waldrop SU-23-CR-0477-S

I think that is all accurate. I don't have much if any knowledge of the case. I didn't suggest any plea offer nor did I talk about the case with Tab. I do know the fact that the hospital refused to comply with the search warrant would have made it very difficult to prosecute as a less safe case. I looked at the accident report and saw that this occurred at 11:30 at night. There is no evidence that the defendant left his lane of travel. The defendant's performance on Field Sobriety Tests was poor according to the officers but for some reason there was no body cam which probably wipes out the felony. I think we would have a very difficult time proving the DUI. Realistically it probably ends up being a Homicide by Vehicle in the 2nd degree after trial.

Robert H Wilson
Senior Assistant District Attorney
Western Judicial Circuit

From: Deborah Gonzalez <Deborah.Gonzalez@accgov.com>
Sent: Tuesday, September 26, 2023 10:43:44 AM
To: Simona Arroyo <Simona.Arroyo@accgov.com>; Lynn Bradberry <Lynn.Bradberry@accgov.com>; Robert Wilson <Robert.Wilson@accgov.com>
Cc: Simona Arroyo <Simona.Arroyo@accgov.com>; Deborah Gonzalez

<Deborah.Gonzalez@accgov.com>

Subject: Re: Luke Waldrop SU-23-CR-0477-S

Robert – what is your input to this before the victim is contacted?

Deborah

From: Simona Arroyo <Simona.Arroyo@accgov.com>

Date: Tuesday, September 26, 2023 at 1:35 PM

To: Lynn Bradberry <Lynn.Bradberry@accgov.com>, Deborah Gonzalez <Deborah.Gonzalez@accgov.com>, Robert Wilson <Robert.Wilson@accgov.com>

Cc: Simona Arroyo <Simona.Arroyo@accgov.com>

Subject: RE: Luke Waldrop SU-23-CR-0477-S

Thank you so very much Lynn. This helps me to understand better, which in turn helps me to explain and answer questions for this and future reference.

Simona Arroyo

Victim Advocate

District Attorney's Office

Western Judicial Circuit

325 E. Washington St.

Suite 370

Athens, GA 30601

Direct Phone: (762) 400-6814

Office Phone: (706) 613-3240 Ext. 6814

Fax: (706) 613-3247



The Unified Government of Athens-Clarke County is a public entity subject to Georgia's Open Records Act OCGA sections 50-18-70 to 50-18-76. Email messages are covered under such laws and are subject to disclosure unless specifically protected by law.

From: Lynn Bradberry <Lynn.Bradberry@accgov.com>

Sent: Tuesday, September 26, 2023 1:25 PM

To: Deborah Gonzalez <Deborah.Gonzalez@accgov.com>; Robert Wilson <Robert.Wilson@accgov.com>

Cc: Simona Arroyo <Simona.Arroyo@accgov.com>

Subject: RE: Luke Waldrop SU-23-CR-Q477-S

Vehicular Homicide cases are always hard because the sentence never measures up to the loss of a life. My comments to these questions are as follows:

Question #1 – below is all the contact that has been made to this victim since the case came into the office. This case was arraigned in June 2022 but it was never placed on a trial calendar until this one.

Question #2 – Tracker does not indicate that a plea offer was ever communicated to the defense or the VA. Tab worked this calendar so I would assume that he is the one that made the offer; however, there is nothing in Tracker about the offer. There is a plea document in Tracker but it is blank. VA attempted to notify victim the day of the plea based on Tab's notes that were sent to Deborah the night before.

Question #3 – Yes - I personally gave Josh the information that the victims were not happy with the plea offer and that they wanted jail time. Josh told the judge that the victim's family was not in agreement with plea and that they wanted him to do jail time. The judge thought about it for a little bit before deciding to accept the plea.

Question #4 – The newspaper does not always print things correctly. The NP in the original case states that the original charging document was dismissed based on a plea agreement to Homicide by Vehicle in the Second Degree and Improper Passing. Defendant refused blood draw even after search warrant was obtained. The hospital refused to draw the blood against the wishes of defendant even when presented with the search warrant.

Question #5 – I would imagine it has to do with the proof issues of the DUI as outline above.

Question #6 – The court was notified that the victims wanted jail time but chose to allow him to plead to straight probation.

Question #7 – these cases are always hard because they do involve a death; however, GA's law regarding VH in the 2nd Degree is a misdemeanor.

Question #8 – Prosecutor presented the court with a factual basis that included the circumstances surrounding how the incident occurred. The judge gave careful consideration to the factual basis and that the victims wanted jail time before ultimately allowing the defendant to plead guilty to the misdemeanor of Homicide by Vehicle in the Second Degree and Improper Passing.

Question #9- Victims have the right to be heard; which did happen because we informed the court on the record of the victim's wishes for jail time; however, the ultimate prosecutorial decision on what should happen with criminal cases is within the discretion of the District Attorney's Office.

****It should be noted that Susan Wilson was not married to the victim and does not meet the CVBOR or Marsy's Law definition of a crime victim. Victim is defined as spouse, children and steps, siblings and steps, parents and steps, grandparents and steps.

The victim's sister was not in agreement with the plea yet she understand the issues and the legal process.

Victim/Witness	Date	Service	Note	Staff
			Susan called in with more questions for the plea that was accepted on her case. Provided answers that I	Simona

Susan Wilson	09/25/2023	4 services	could. Advised that I would call back with other answers when I get them.	Arroyo	Show/Edit
Susan Wilson	09/21/2023	4 services	Called to give result of plea. Offered additional support if needed.	Simona Arroyo	Show/Edit
Susan Wilson	09/21/2023	4 services	TTC partner to give details of plea offer and to notify of upcoming trial LVM	Simona Arroyo	Show/Edit
Susan Wilson	09/30/2022	Individual Support	TTC V as she requested - no answer, left vm & texted, per V request	Alice Hayes	Show/Edit
Susan Wilson	09/28/2022	2 services	Rec'd & responded to email from V - see notes	Alice Hayes	Show/Edit
Susan Wilson	08/30/2022	Individual Support	Called V to "check in" - no answer, left vm stating I was calling to check in & see how everything is going, & could V please return my call @ her convenience	Alice Hayes	Show/Edit
Susan Wilson	08/12/2022	2 services	Emailed V list of counseling resources - see notes	Alice Hayes	Show/Edit
Susan Wilson	08/10/2022	4 services	Meeting w/ V (1hr 10mins) to advise on VIS and restitution form; discuss needs/resources (see notes)	Alice Hayes	Show/Edit
Susan Wilson	08/04/2022	Individual Support	Called V to "check in" - see notes. Scheduled appointment w/ V for 8/10/22 @ 9:30	Alice Hayes	Show/Edit
Susan Wilson	07/15/2022	2 services	Rec'd 2 emails from V- see notes; did not respond to emails, called her instead. Sent separate email with possible resources; see notes.	Alice Hayes	Show/Edit
Susan Wilson	07/14/2022	5 services	Emailed copy of initial contact/intake paperwork, per V request	Alice Hayes	Show/Edit
Susan Wilson	07/14/2022	2 services	TC to V, discussed financial needs & possible resources - see notes. Emailed link/referral to Athens Land Trust Homebuyer Education Classes.	Alice Hayes	Show/Edit
Susan Wilson	07/14/2022	Individual Support	TC to V, discussed financial needs & possible resources - see notes. Emailed link/referral to Athens Land Trust Homebuyer Education Classes.	Alice Hayes	Show/Edit

Susan Wilson	07/06/2022	2 services	Emailed V list of financial assistance resources - see notes	Alice Hayes	Show/Edit
Susan Wilson	06/30/2022	Individual Support	Called to discuss V's financial needs - V asked if I could call her back Tuesday morning. Advised I will be in trial but Tuesday morning could work- depends on how long jury selection lasts. Will f/u with V.	Alice Hayes	Show/Edit
Susan Wilson	06/27/2022	2 services	Called V - she was teaching class & couldn't talk. Let her know I got her email & responded but we're having server issues; I will re-send ASAP.	Alice Hayes	Show/Edit
Susan Wilson	06/27/2022	5 services	Responded to email from V - email immediately bounced back, we are having internet issues today. Will re-send ASAP.	Alice Hayes	Show/Edit
Susan Wilson	06/22/2022	4 services	Notified of Arraignment outcome (in person- Ms. Wilson attended Arraignment)	Alice Hayes	Show/Edit
Susan Wilson	06/22/2022	CJS Victim Support & Advocacy	Attended court with Susan Wilson	Alice Hayes	Show/Edit
Susan Wilson	06/22/2022	CJS Victim Notification	ACC phones are down/cannot receive incoming calls - texted V so she'd have a way to contact me	Alice Hayes	Show/Edit
Susan Wilson	06/21/2022	4 services	Rec'd call from V - discussed what to expect tomorrow (Arraignment)	Alice Hayes	Show/Edit
Susan Wilson	06/17/2022	2 services	V called - wanted to know if she can have a friend accompany her to arraignment for support. Advised that should be fine	Alice Hayes	Show/Edit
Susan Wilson	06/14/2022	4 services	Notified of Arraignment via phone & email - see notes	Alice Hayes	Show/Edit
2 victims	05/17/2022	2 services	Attended court	Alice Hayes	Show/Edit

Susan Wilson	04/15/2022	2 services	Texted V to confirm email address & contact info for Melody Jones	Alice Hayes	Show/Edit
Susan Wilson	04/15/2022	2 services	Emailed V, per her request - it bounced back undeliverable. Will text instead.	Alice Hayes	Show/Edit
Susan Wilson	04/15/2022	4 services	Mailed initial contact packet	Alice Hayes	Show/Edit
Susan Wilson	04/15/2022	4 services	TC from V - see notes	Alice Hayes	Show/Edit
Susan Wilson	04/15/2022	CJS Victim Support & Advocacy	Received vm from V. Returned her call, no answer, left vm.	Alice Hayes	Show/Edit
Susan Wilson	04/12/2022	CJS Victim Notification	TC to V to introduce self - no answer, left vm asking Susan Wilson to return my call	Alice Hayes	Show/Edit

From: Deborah Gonzalez <Deborah.Gonzalez@accgov.com>
Sent: Tuesday, September 26, 2023 10:18 AM
To: Robert Wilson <Robert.Wilson@accgov.com>
Cc: Simona Arroyo <Simona.Arroyo@accgov.com>; Deborah Gonzalez <Deborah.Gonzalez@accgov.com>; Lynn Bradberry <Lynn.Bradberry@accgov.com>
Subject: Re: Luke Waldrop SU-23-CR-0477-S

Robert – my understanding is you either made this plea offer or helped Tab with it – so please help provide answers to Simona.

Lynn/Simona – we need to make sure victims are notified.

Thank you,

Deborah

From: Simona Arroyo <Simona.Arroyo@accgov.com>
Date: Tuesday, September 26, 2023 at 10:12 AM
To: Deborah Gonzalez <Deborah.Gonzalez@accgov.com>, Robert Wilson <Robert.Wilson@accgov.com>
Cc: Simona Arroyo <Simona.Arroyo@accgov.com>
Subject: Luke Waldrop SU-23-CR-0477-S

Good morning,

The victim's partner of 37 years, Susan Wilson (706-461-6713) called in on Friday and on yesterday to discuss the outcome of the plea that Waldrop took. She was understandably upset and had several questions: A few that I had answers for and some I did not have answers for. She also made reference to a news article that was published about the case. I met with Robert and he thought it best to bring you in on this.

1. She wanted to know why she hadn't been contacted for the past year prior to my initial contact with her. In summary, I apologized and let her know that is not reflective of how we interact with victims in this office. See all contact listed above
2. Who put the plea on the table? Our office or the Defense Office?
3. Where her wishes taken into account at all at any point in time and was it told/given to the judge?
4. Why did the news article say that there wasn't enough evidence when the pictures and police report show and state plenty of evidence?
5. How was a felony death plead down to a misdemeanor?
6. Why wasn't time to serve given? Was it not an option?
7. How can a death be a misdemeanor?
8. What evidence was presented when it was obvious by the pictures and police report that Waldrop was DUI?
9. Is there anything that the victim survivors can do to reject or protest the judgement?

I did advise her that either myself, or someone from this office will return her call when we have answers for her questions and concerns.

Thank you,

Simona Arroyo

Victim Advocate
District Attorney's Office
Western Judicial Circuit
325 E. Washington St.
Suite 370
Athens, GA 30601

Direct Phone: (762) 400-6814
Office Phone: (706) 613-3240 Ext. 6814
Fax: (706) 613-3247



The Unified Government of Athens-Clarke County is a public entity subject to Georgia's Open Records Act OCGA sections 50-18-70 to 50-18-76. Email messages are covered under such laws and are subject to disclosure unless specifically protected by law.

EXHIBIT
M-11
tabbles

Letter to the Editor

Letters to The Oconee Enterprise, P.O. Box 535, Watkinsville, Georgia 30677 or e-mail to editor@oconeeenterprise.com. Letters must not exceed 300 laytime phone number. The editor reserves the right to edit letters, especially for length due to space considerations.

As it states on the cover of "Flamer," "this book will save lives," but only if it remains in its proper placement in the library.

So, who is truly trying to protect our children?

—Bert DeSimone
Bishop

Gonzalez responds

As a team, our office has prioritized working in collaboration with our law enforcement partners to keep the residents of Clarke and Oconee counties safe, ensuring that justice is served with due process and that victims of crimes are accorded certain basic rights. Victim advocacy is paramount to the work we do.

Attorney Kevin Epps has once again chosen to divert at-

tention from the notable work of the DA's office and instead focus on unfounded allegations. We will not be distracted by political partisanship that does not reflect our commitment to creating a safer, more just and equitable community.

We advise that Attorney Epps spend more time investigating the facts in the cases of the people he claims to represent. In the case of one victim, our office did its due diligence in contacting the victim's family multiple times and keeping them informed as case details were available. In response to the second case, we cannot comment as the case has been true-billed by a grand jury. It is an active case and cannot be discussed.

This office continues prioritizing professionalism in prose-

cuting violent offenders, protecting our community and upholding justice. The Western Judicial Circuit will always ensure that every victim is treated with respect and dignity.

—Deborah Gonzalez
Athens

U.S. House should be held accountable

I have been having a meaningful exchange with a loved one about the current status of our U.S. House of Representatives. He feels the members of the House should not be paid during the time they are unable to do the peoples' business. I have countered that some, per-

haps not all, have been "working," even though officially they cannot transact some business.

For me, it is like thinking about people during the pandemic who were told to work at home.

We all know that many people "worked" from home, and some people just "went home" and claimed they were working. I think it would be useful to ask those who represent us to give us an accounting of their work during this time. You might recall the old expression, "No taxation without representation." Do you recall how that ended?

—Margaret E. Holt
Watkinsville

Simona Arroyo

From: Tab Hunter
Sent: Thursday, September 21, 2023 12:25 AM
To: Deborah Gonzalez
Cc: Jennie De La Vega; Felicia Fortson; Lynn Bradberry; Simona Arroyo; Martha Perkins
Subject: Judge Lawton E. Stephens Plea Calendar 9-21-2023
Attachments: Tab Hunter - Status - Trial Calendar 9-21-2023.pdf; Tab Hunter - Status - Trial Calendar 9-21-2023.docx

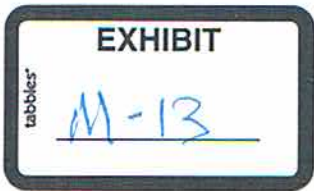

Tab. I need a list of each case with any plea offer made and the def attorney.

1. State of Georgia vs. Luke Harrison Waldrop

Attorney: Robbie M. Ballard

Plea Agreement: (M) Homicide by Vehicle – Second Degree
(M) Safe Passing Distance when Overtaking a Bicyclist (“Improper Passing”)
Probation

[Accusation prepared]



COLLOQUY BETWEEN JUDGE LAWTON E. STEPHENS AND DEBORAH GONZALEZ
AT CONCLUSION OF COURT PROCEEDINGS ON SEPTEMBER 21, 2023

1 THE COURT: So all right. Appreciate y'all's --

2 MS. GONZALEZ: So, Your Honor, I'd just like to make
3 one announcement. I see that we don't have any cases left
4 for trial --

5 THE COURT: That's right.

6 MS. GONZALEZ: -- at this point --

7 THE COURT: Yeah.

8 MS. GONZALEZ: -- which is good because, Your Honor,
9 Mr. Hunter left your courtroom yesterday and resigned
10 which is the reason why I had to come even with --

11 THE COURT: Was it something I said?

12 MS. GONZALEZ: Yes, actually it was something that
13 you said and the way that you said it.

14 THE COURT: What did I say?

15 MS. GONZALEZ: And you were very rude to him
16 yesterday.

17 THE COURT: Come on up. Let's be on the record.

18 MS. GONZALEZ: And this has been --

19 THE COURT: Let's be on the record here.

20 MS. GONZALEZ: Yes.

21 THE COURT: Come up to the podium, please.

22 MS. GONZALEZ: Your Honor, if I can stay here because
23 this does not give me a lot of mobility.

24 THE COURT: I just want to make sure I can hear your
25 comments on the record.

1 MS. GONZALEZ: Okay. But yes, Your Honor. And this
2 has come up more than once in your courtroom and him being
3 very upset at the way that he's been treated. But it
4 takes me months to recruit these individuals. And it took
5 three weeks of him being in your courtroom and he
6 resigned.

7 THE COURT: Yeah.

8 MS. GONZALEZ: And this has put us in a really bad
9 situation.

10 THE COURT: Okay.

11 MS. GONZALEZ: As you see, I've had to come here with
12 a broken ankle against the advice of my doctor --

13 THE COURT: Yeah.

14 MS. GONZALEZ: -- to have somebody here in front of
15 you to take care of this calendar.

16 THE COURT: Okay.

17 MS. GONZALEZ: And I do just want it noted on the
18 record of why he resigned.

19 THE COURT: Okay.

20 MS. GONZALEZ: And it was because of what you said in
21 your courtroom.

22 THE COURT: So what did I say that was rude? I said
23 be on time; was that rude?

24 MS. GONZALEZ: No, Your Honor. It's also the way
25 that you say things.

1 THE COURT: I said subpoena witnesses that weren't
2 subpoenaed; was that rude?

3 MS. GONZALEZ: You know, there are ways that we can
4 talk to people. And even when you and I had that
5 conversation on the phone yesterday and you said well, I
6 hold him to, you know, certain expectations and I treat
7 people differently. Josh is new. You treated him great
8 today. You could've given that same grace to --

9 THE COURT: Right.

10 MS. GONZALEZ: -- Tab Hunter when he was here in your
11 courtroom.

12 THE COURT: Understand something. Understand that it
13 was represented to me by your office and by reviewing Mr.
14 Hunter's resume that he was a seasoned trial attorney and
15 that he was expected to know these things. Mr. Neal is a
16 law student. I didn't expect him to know these things.
17 But it was represented to me that Mr. Hunter had tried
18 many --

19 MS. GONZALEZ: And, Your Honor --

20 THE COURT: -- cases in court and I expected him to
21 be able to do it.

22 MS. GONZALEZ: And knowing --

23 THE COURT: That's why he was treated differently --

24 MS. GONZALEZ: -- knowing trial skills --

25 THE COURT: -- because the expectations of a seasoned

1 trial attorney are different than from a law student.

2 MS. GONZALEZ: And just like we spoke yesterday, Your
3 Honor, knowing trial skills and knowing these cases when
4 you're first brought into a brand new court where you have
5 to learn the facts and learn the people and learn the
6 parties and learn the judge and learn everybody else in
7 this courtroom. Okay?

8 THE COURT: Right.

9 MS. GONZALEZ: Not anybody can just walk in and just
10 do everything one hundred percent. And giving a little
11 grace can go a long way. But right now, Your Honor, I
12 don't have an ADA for your courtroom.

13 THE COURT: Right. Right. Well, I'll say this. I
14 do expect a lot from lawyers who come in and represent the
15 State. I expect a minimum amount of competence in the
16 law. I expect if I -- if I schedule a hearing on July the
17 5th for September the 18th and an attorney from the State
18 appears and says none of the witnesses have been
19 subpoenaed that I'm going to -- I think that I should hold
20 your office accountable.

21 MS. GONZALEZ: Yes.

22 THE COURT: Specifically hold you accountable, too --

23 MS. GONZALEZ: And hold me accountable.

24 THE COURT: -- because you're in charge.

25 MS. GONZALEZ: And you can call me in this courtroom.

1 THE COURT: Right.

2 MS. GONZALEZ: But the way that you treated him and
3 the way that you spoke to him was inappropriate. And I
4 even called you and said anytime that you have an issue,
5 you can call me and I will be here just like I had my
6 investigator pick me up today because I cannot walk, okay
7 --

8 THE COURT: Right.

9 MS. GONZALEZ: -- to be here for you. And all I'm
10 saying is that there are ways to talk to people and to
11 treat people. This is a very intense place to work in.
12 Okay? And what we --

13 THE COURT: Right. Yeah, especially because you're
14 so short-staffed.

15 MS. GONZALEZ: Yes, we are short-staffed.

16 THE COURT: Very short-staffed.

17 MS. GONZALEZ: And like I said, it takes a lot to
18 bring them in. But it certainly doesn't take nothing to
19 have them run away.

20 THE COURT: Right. Well --

21 MS. GONZALEZ: And it's not going to help us if we
22 keep losing them. Okay?

23 THE COURT: That's right.

24 MS. GONZALEZ: It doesn't help us. It doesn't help
25 anybody to get this stuff done.

1 THE COURT: Well, I -- I'm going to -- I mean, I
2 think when somebody is the district attorney, elected
3 district attorney, employed by the district attorney's
4 office as an assistant district attorney, I'm going to
5 hold them to a high degree of responsibility and
6 competence. And if I don't see it, I'm going to call it
7 out. And it's time after time after time after time I've
8 seen it with your assistant district attorneys that have
9 appeared in front of me not subpoenaing witnesses, not
10 subpoenaing witnesses for restitution hearings, not
11 knowing who their witnesses are for Jackson-Denno
12 hearings.

13 MS. GONZALEZ: And part of that has been the
14 turnover, Your Honor.

15 THE COURT: Right. The turnover --

16 MS. GONZALEZ: And part of that is I have come to ask
17 you --

18 THE COURT: And I can't -- it is your -- I think --

19 MS. GONZALEZ: I have asked you --

20 THE COURT: There's a lot of reasons why people are
21 quitting from your office and it's not because they're
22 being treated rudely in court. It's for a lot of other
23 reasons.

24 MS. GONZALEZ: Oh, I can give you some of those that
25 --

1
2
3
4
5
6
7
8
9
10
11
12
13
14
15
16
17
18
19
20
21
22
23
24
25

THE COURT: I'm sure you can.

MS. GONZALEZ: Not everything has been --

THE COURT: But I'm telling you right now I'm going to hold them responsible.

MS. GONZALEZ: -- because of me, Your Honor. Okay?

THE COURT: I'm not going to hold their hands just because they just started because there's been so much turnover.

MS. GONZALEZ: And I'm not asking you to hold their hands. I am asking you to be professional and courtesy with them --

THE COURT: Okay.

MS. GONZALEZ: -- as they're trying to do this job and learn it the way that they need to.

THE COURT: Right.

MS. GONZALEZ: Okay?

THE COURT: Who are they learning it from?

MS. GONZALEZ: Well, that's part of the issue, Your Honor.

THE COURT: Who are they learning it from, Ms. Gonzalez, at long last?

MS. GONZALEZ: From PAC trainers when I am able to get them to training. Right?

THE COURT: Right.

MS. GONZALEZ: But the problem is if I am

1
2
3
4
5
6
7
8
9
10
11
12
13
14
15
16
17
18
19
20
21
22
23
24

understaffed, I don't have coverage for them to go to training.

THE COURT: Right.

MS. GONZALEZ: This is something that I've brought to your attention, that I have brought to all the judges' attention --

THE COURT: Oh, yeah. Right.

MS. GONZALEZ: -- including one that when we were supposed to have summer conference, they decided to have a trial week.

THE COURT: Right. All right. So my suggestion to you -- and this is my final comment -- is that you look to yourself before you blame other people for all the issues that you're facing in the district attorney's office. And that's my final comment. Thank you.

MS. GONZALEZ: Well, thank you, Your Honor. And I have. But as somebody who has -- is trying to manage over 40 people --

THE COURT: Right.

MS. GONZALEZ: -- it's not really something that you can say when you're managing two or three.

THE COURT: Court is adjourned.

CERTIFICATE

STATE OF GEORGIA

COUNTY OF JACKSON

I, Misti H. Colley, Certified Court Reporter, -2516, hereby certify that the foregoing pages numbered 2 through 9 constitute a true, complete and accurate transcript of Colloquy Between Judge Lawton E. Stephens and Deborah Gonzalez at Conclusion of Court Proceedings on September 21, 2023, taken down by me and transcribed under my supervision to the best of my ability.

In witness whereof, I hereby affix my hand on this the 21st day of September, 2023.

Misti H. Colley
Misti H. Colley, CCR-2516





On Wednesday, Tab Hunter walked out of Judge Stephen's courtroom and resigned. He felt he had been bullied and disrespected and from individuals who were witnesses to this treatment, I concur.

So yesterday I confronted Judge Stephens in court, calling out his unprofessional behavior. Judge Stephens said some things and got a bit personal, but I stood my ground defending my office and those who work for me – you. Standing up to bullies is difficult and doing it with a broken ankle on a knee scooter in pain is not the ideal way to do it. But it had to be done.

I am sorry Tab left us, as well as others. But I've learned along the way everyone has their own path to follow. Some people join our journey for a little while, others are there for a substantial distance, all bring a gift for which we need to be grateful for.

EFIL
CLERK OF
ATHENS-CLARKE COUNTY
SU22CR0321- S
11/3/2023 10:02AM

Elisa Zarate
ELISA ZARATE, Clerk

IN THE SUPERIOR COURT OF ATHENS-CLARKE COUNTY
STATE OF GEORGIA

STATE OF GEORGIA, :
 :
 vs. :
 :
 LUKE HARRISON WALDROP, :
 :
 DEFENDANT. :
 :
 _____ :

CASE NO. SU-22-CR-0321

Related Case: SU-23-CR-0477

NOTICE OF FILING SUBPOENAS

Movant Susan Wilson gives notice that she has served the enclosed subpoenas to the following:

- 1) Deborah Gonzalez, 325 E. Washington Street, Suite 370, Athens, Georgia 30601 via Hand Delivery.
- 2) Joshua Neal, Office of the District Attorney for the Western Judicial Circuit via Hand Delivery.
- 3) Simona Arroyo, Office of the District Attorney for the Western Judicial Circuit via Hand Delivery.
- 4) Alice Hayes via Electronic Mail upon consent.

This the 3rd day of November 2023.

**EPPS, HOLLOWAY, DELOACH
& HOIPKEMIER, LLC**

BY: /s/ Kevin E. Epps
Kevin E. Epps
Georgia Bar No. 785511
Attorney for Movant

1220 Langford Drive
Building 200-101
Watkinsville, Georgia 30677
(706) 508-4000
kevin@ehdhlaw.com

SUBPOENA DUCES TECUM
State of Georgia, Clarke County

TO: **Joshua Neal**
Office District Attorney for the Western Judicial Circuit
325 E. Washington Street, Suite 370
Athens, GA 30601

YOU ARE HEREBY COMMANDED, that laying all other business aside you are hereby required to be and appear at the Athens-Clarke County Courthouse, 325 E. Washington Street, Athens, Georgia 30601 on the 6th day of November 2023 at 10:30 a.m. to testify in the case of State of Georgia v Luke Harrison Waldrop, Case Number SU22CR0321, hearing on Marsy's law violation, pending in the Superior Court of Athens-Clarke County. You are required to attend from day to day and from time to time until the matter is disposed of.

Pursuant to O.C.G.A. § 24-13-23, this subpoena requires you to produce the following documents in your possession, custody, or control:

1. Any and all documents related to the case of the State of Georgia v. Luke Harrison Waldrop, Case Number SU22CR0321 (Athens-Clarke County)—including, but not limited to—Tracker notes; SMS messages; interoffice correspondence; texts, letters, and/or email correspondence with witnesses, the victim, or the victim's family; calendar notes from any dates where the matter was called before the court; and copies of all subpoenas issued by the State or the Western Judicial Circuit's District Attorney's Office.

HEREIN FAIL NOT, under penalty of law by authority of the Honorable Lawton Stephens, Judge of said Court this 2nd day of November 2023.

Any questions, contact:
Kevin E. Epps
Attorney for Movant
1220 Langford Drive
Building 200-101
Watkinsville, Georgia 30677
706-508-4000

Elisa Zarate
Clerk of Superior Court
(706) 613-3190

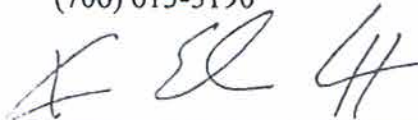

Subpoena issued by Attorney of Record
for Movant pursuant to O.C.G.A. § 24-13-21(d)

RETURN OF SERVICE

I served the within witness, Joshua Neal, with this Witness Subpoena on November 2, 2023 via Hand Delivery.

Served by:

Emerson Hines

"Pursuant to O.C.G.A § 24-13-21(c-h), this subpoena form is being provided to the attorney of record and shall be completed prior to service upon the witness. If an individual misuses a subpoena, he or she shall be subject to punishment for contempt of court and shall be punished by a fine of not more than \$300.00 or not more than 20 days imprisonment, or both. A witness may contact the Clerk of Court's office to verify this subpoena was issued for a valid case."

SUBPOENA DUCES TECUM
State of Georgia, Clarke County

TO: Simona Arroyo
Office District Attorney for the Western Judicial Circuit
325 E. Washington Street, Suite 370
Athens, GA 30601

YOU ARE HEREBY COMMANDED, that laying all other business aside you are hereby required to be and appear at the Athens-Clarke County Courthouse, 325 E. Washington Street, Athens, Georgia 30601 on the 6th day of November 2023 at 10:30 a.m. to testify in the case of State of Georgia v Luke Harrison Waldrop, Case Number SU22CR0321, hearing on Marsy's law violation, pending in the Superior Court of Athens-Clarke County. You are required to attend from day to day and from time to time until the matter is disposed of.

Pursuant to O.C.G.A. § 24-13-23, this subpoena requires you to produce the following documents in your possession, custody, or control:

1. Any and all documents related to the case of the State of Georgia v. Luke Harrison Waldrop, Case Number SU22CR0321 (Athens-Clarke County)—including, but not limited to—Tracker notes; SMS messages; interoffice correspondence; texts, letters, and/or email correspondence with witnesses, the victim, or the victim's family; calendar notes from any dates where the matter was called before the court; and copies of all subpoenas issued by the State or the Western Judicial Circuit's District Attorney's Office.

HEREIN FAIL NOT, under penalty of law by authority of the Honorable Lawton Stephens, Judge of said Court this 2nd day of November 2023.

Any questions, contact:
Kevin E. Epps
Attorney for Movant
1220 Langford Drive
Building 200-101
Watkinsville, Georgia 30677
706-508-4000

Elisa Zarate
Clerk of Superior Court,
(706) 613-3190

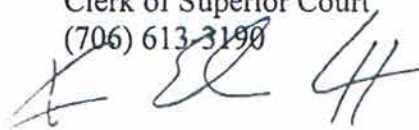

Subpoena issued by Attorney of Record
for Movant pursuant to O.C.G.A. § 24-13-21(d)

RETURN OF SERVICE

I served the within witness, Simona Arroyo, with this Witness Subpoena on November 2, 2023 via Hand Delivery.

Served by: 
Emerson Hines

"Pursuant to O.C.G.A § 24-13-21(c-h), this subpoena form is being provided to the attorney of record and shall be completed prior to service upon the witness. If an individual misuses a subpoena, he or she shall be subject to punishment for contempt of court and shall be punished by a fine of not more than \$300.00 or not more than 20 days imprisonment, or both. A witness may contact the Clerk of Court's office to verify this subpoena was issued for a valid case."

SUBPOENA DUCES TECUM
State of Georgia, Clarke County

TO: **Deborah Gonzalez**
Office District Attorney for the Western Judicial Circuit
325 E. Washington Street Suite 370
Athens, GA 30601

YOU ARE HEREBY COMMANDED, that laying all other business aside you are hereby required to be and appear at the Athens-Clarke County Courthouse, 325 E. Washington Street, Athens, Georgia 30601 on the 6th day of November 2023 at 10:30 a.m. to testify in the case of *State of Georgia v Luke Harrison Waldrop*, Case Number SU22CR0321, hearing on Marsy's law violation, pending in the Superior Court of Athens-Clarke County. You are required to attend from day to day and from time to time until the matter is disposed of.

Pursuant to O.C.G.A. § 24-13-23, this subpoena requires you to produce the following documents in your possession, custody, or control:

1. Any and all documents related to the case of the State of Georgia v. Luke Harrison Waldrop, Case Number SU22CR0321 (Athens-Clarke County)—including, but not limited to—the entire case file; Tracker notes; any and all correspondence with the Prosecuting Attorneys' Council (PAC); SMS messages; interoffice correspondence; texts, letters, and/or email correspondence with witnesses, the victim, or the victim's family; calendar notes from any dates where the matter was called before the court; and copies of all subpoenas issued by the State or the Western Judicial Circuit's District Attorney's Office.

HEREIN FAIL NOT, under penalty of law by authority of the Honorable Lawton Stephens, Judge of said Court this 2nd day of November, 2023.

Any questions, contact:
Kevin E. Epps
Attorney for Movant
1220 Langford Drive
Building 200-101
Watkinsville, Georgia 30677
706-508-4000

Elisa Zarate
Clerk of Superior Court
(706) 613-3190



Subpoena issued by Attorney of Record
for Movant pursuant to O.C.G.A. § 24-13-21(d)

RETURN OF SERVICE

I served the within witness, Deborah Gonzalez, with this Witness Subpoena on November 2, 2023 via Hand Delivery.

Served by: 
Emerson Hines

"Pursuant to O.C.G.A § 24-13-21(c-h), this subpoena form is being provided to the attorney of record and shall be completed prior to service upon the witness. If an individual misuses a subpoena, he or she shall be subject to punishment for contempt of court and shall be punished by a fine of not more than \$300.00 or not more than 20 days imprisonment, or both. A witness may contact the Clerk of Court's office to verify this subpoena was issued for a valid case."

SUBPOENA DUCES TECUM
State of Georgia, Clarke County

TO: **Alice Hayes**
aliceclaudiahayes@gmail.com

YOU ARE HEREBY COMMANDED, that laying all other business aside you are hereby required to be and appear at the Athens-Clarke County Courthouse, 325 E. Washington Street, Athens, Georgia 30601 on the 6th day of November 2023 at 10:30 a.m. to testify in the case of State of Georgia v Luke Harrison Waldrop, Case Number SU22CR0321, hearing on Marsy's law violation, pending in the Superior Court of Athens-Clarke County. You are required to attend from day to day and from time to time until the matter is disposed of.

Pursuant to O.C.G.A. § 24-13-23, this subpoena requires you to produce the following documents in your possession, custody, or control:

1. Any and all documents related to the case of the State of Georgia v. Luke Harrison Waldrop, Case Number SU22CR0321 (Athens-Clarke County)—including, but not limited to—Tracker notes; SMS messages; interoffice correspondence; texts, letters, and/or email correspondence with witnesses, the victim, or the victim's family; calendar notes from any dates where the matter was called before the court; and copies of all subpoenas issued by the State or the Western Judicial Circuit's District Attorney's Office.

HEREIN FAIL NOT, under penalty of law by authority of the Honorable Lawton Stephens, Judge of said Court this 3rd day of November 2023.

Any questions, contact:
Kevin E. Epps
Attorney for Movant
1220 Langford Drive
Building 200-101
Watkinsville, Georgia 30677
706-508-4000

Elisa Zarate
Clerk of Superior Court
(706) 613-3190



Subpoena issued by Attorney of Record
for Movant pursuant to O.C.G.A. § 24-13-21(d)

RETURN OF SERVICE

I served the within witness, Alice Hayes, with this Witness Subpoena on November 3, 2023 via statutory electronic service.

Served by: Brittany Lane
Brittany Lane, Paralegal

"Pursuant to O.C.G.A § 24-13-21(c-h), this subpoena form is being provided to the attorney of record and shall be completed prior to service upon the witness. If an individual misuses a subpoena, he or she shall be subject to punishment for contempt of court and shall be punished by a fine of not more than \$300.00 or not more than 20 days imprisonment, or both. A witness may contact the Clerk of Court's office to verify this subpoena was issued for a valid case."

Jennie De La Vega

From: Tab Hunter
Sent: Thursday, September 21, 2023 12:25 AM
To: Deborah Gonzalez
Cc: Jennie De La Vega; Felicia Fortson; Lynn Bradberry; Simona Arroyo; Martha Perkins
Subject: Judge Lawton E. Stephens Plea Calendar 9-21-2023
Attachments: Tab Hunter - Status - Trial Calendar 9-21-2023.pdf; Tab Hunter - Status - Trial Calendar 9-21-2023.docx



Jennie De La Vega

From: Tab Hunter
Sent: Thursday, September 21, 2023 12:28 AM
To: Jennie De La Vega
Subject: End of service

Thank you very much for the opportunity to serve as a prosecutor with the Western Judicial Circuit. Please accept my gratitude with this notice of my intention to end my service effective 8:00 a.m., Thursday, September 21, 2023. Truly,
Tab C. Hunter



CERTIFICATE

STATE OF GEORGIA

COUNTY OF JACKSON

I, Misti H. Colley, Certified Court Reporter, -2516, hereby certify that the foregoing constitute exhibits tendered and admitted in the hearing on Marsy's Law violation in the case of State v. Luke Harrison Waldrop, heard before the Honorable Lawton E. Stephens, Judge of the Superior Courts of the Western Judicial Circuit, Athens-Clarke County Case No. SU-22-CR-0321-S, SU-23-CR-0477-S, taken down by me and transcribed under my supervision to the best of my ability.

I further certify that I am a disinterested party to this action and that I am neither of kin nor counsel to any of the parties hereto.

This certification is expressly withdrawn and denied upon disassembly, photocopying, or duplication in any manner or upon certification of the foregoing transcript or any part thereof by any person or entity other than by me. This certification is further expressly withdrawn and denied absent my original signature and original seal appearing hereon below.

In witness whereof, I hereby affix my hand on this the 20th day of February, 2024.

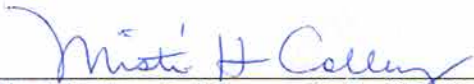
Misti H. Colley, CCR-2516

